



Xpert[®] Xpress CoV-2/Flu/RSV *plus*

For use with GeneXpert[®] System with Touchscreen



Catalog Numbers

REF XPRS4PLEX-10

303-1854 | Rev. A | 2024-02

R_xonly **IVD** In Vitro Diagnostic Medical Device

Trademark, Patents and Copyright Statements

Cepheid®, the Cepheid logo, GeneXpert®, and Xpert® are trademarks of Cepheid, registered in the U.S. and other countries.

All other trademarks are the property of their respective owners.

THE PURCHASE OF THIS PRODUCT CONVEYS TO THE BUYER THE NON-TRANSFERABLE RIGHT TO USE IT IN ACCORDANCE WITH THESE INSTRUCTIONS FOR USE. NO OTHER RIGHTS ARE CONVEYED EXPRESSLY, BY IMPLICATION OR BY ESTOPPEL. FURTHERMORE, NO RIGHTS FOR RESALE ARE CONFERRED WITH THE PURCHASE OF THIS PRODUCT.

© 2024 Cepheid.

See [Revision History](#) for a description of changes.

Table of Contents

	Getting Started.....	5
	Product Information.....	5
	Proprietary Name.....	5
	Common or Usual Name	5
	Intended Use, Summary, and Principle of Procedure	5
	Intended Use.....	5
	Summary and Explanation.....	6
	Principle of the Procedure.....	6
	Reagents, Instruments, and Materials.....	8
	Reagents	8
	Materials Provided.....	8
	Materials Required but Not Provided	9
	Materials Available but Not Provided.....	9
	Warnings and Precautions	9
	General.....	10
	Specimens	10
	Assay/Reagent	11
	Chemical Hazards, Storage and Handling	12
	Chemical Hazards.....	12
	Storage and Handling	12
	Specimen Collection, Testing, and Results	13
	Specimen Collection.....	13
	Specimen Collection, Transport, and Storage.....	13
	Procedure	13
	Preparing the Cartridge	13
	External Controls	14
	Starting the Test: GeneXpert System with Touchscreen.....	15
	Viewing Results: GeneXpert System with Touchscreen	16
	Quality Control	16
	Internal Controls.....	16
	External Controls	17
	Results.....	17
	Reasons to Repeat the Test	22
	Retest Procedure	23
	Limitations	23
	Limitations of the Procedure	23
	Expected Values	25

!	Specific Performance Characteristics	27
	Clinical Performance	27
	Clinical Evaluation	27
	Analytical Performance.....	32
	Analytical Sensitivity / Limit of Detection (LoD)	32
	Analytical Reactivity (Inclusivity)	34
	Analytical Specificity (Exclusivity).....	38
	Microbial Interference	41
	Competitive Interference.....	42
	Potentially Interfering Substances.....	43
	Carry-over Contamination.....	47
	Single-Site Precision	48
	Reproducibility	48
?	Appendix.....	52
	Bibliography.....	52
	Cepheid Headquarters Locations	52
	Technical Assistance.....	53
	Table of Symbols	53
	Revision History.....	54



Getting Started

Product Information

Proprietary Name

Xpert[®] Xpress CoV-2/Flu/RSV *plus*

Common or Usual Name

Xpert Xpress CoV-2/Flu/RSV *plus*

Intended Use, Summary, and Principle of Procedure

Intended Use

Xpert[®] Xpress CoV-2/Flu/RSV *plus* test, performed on the GeneXpert System with Touchscreen, is an automated multiplexed real-time reverse transcriptase polymerase chain reaction (RT-PCR) test intended for use in the simultaneous *in vitro* qualitative detection and differentiation of severe acute respiratory syndrome coronavirus (SARS-CoV-2), influenza A, influenza B, and/or respiratory syncytial virus (RSV) viral RNA in nasopharyngeal swab and anterior nasal swab specimens collected from individuals with signs and symptoms of respiratory tract infection. Clinical signs and symptoms of respiratory tract infection due to SARS-CoV-2, influenza A, influenza B, and RSV can be similar.

The Xpert Xpress CoV-2/Flu/RSV *plus* is intended for use in the differential detection of SARS-CoV-2, influenza A, influenza B and/or RSV RNA and aids in the diagnosis of COVID-19, influenza and/or RSV infections if used in conjunction with other clinical and epidemiological information, and laboratory findings. SARS-CoV-2, influenza A, influenza B, and RSV viral RNA are generally detectable in nasopharyngeal swab and anterior nasal swab specimens during the acute phase of infection.

Positive results are indicative of the presence of the identified virus, but do not rule out bacterial infection or co-infection with other pathogens not detected by the test. The agent(s) detected by the Xpert Xpress CoV-2/Flu/RSV *plus* test may not be the definite cause of disease.

Negative results do not preclude SARS-CoV-2, influenza A, influenza B and/or RSV infection. The results of this test should not be used as the sole basis for diagnosis, treatment, or other patient management decisions.



Summary and Explanation

An outbreak of respiratory illness of unknown etiology in Wuhan City, Hubei Province, China was initially reported to the World Health Organization (WHO) on December 31, 2019.¹ Chinese authorities identified a novel coronavirus (2019-nCoV), which has since spread globally, resulting in a pandemic of coronavirus disease 2019 (COVID-19). COVID-19 is associated with a variety of clinical outcomes, including asymptomatic infection, mild upper respiratory infection, severe lower respiratory disease including pneumonia and respiratory failure, and in some cases, death. The International Committee on Taxonomy of Viruses (ICTV) renamed the virus SARS-CoV-2.²

Influenza, or the flu, is a contagious viral infection of the respiratory tract. Transmission of influenza is primarily via aerosolized droplets (i.e., coughing or sneezing) and the peak of transmission usually occurs in the winter months. Symptoms commonly include fever, chills, headache, malaise, cough and sinus congestion. Gastrointestinal symptoms (i.e., nausea, vomiting or diarrhea) may also occur, primarily in children, but are less common. Symptoms generally appear within two days of exposure to an infected person. Pneumonia may develop as a complication due to influenza infection, causing increased morbidity and mortality in pediatric, elderly, and immunocompromised populations.^{3,4}

Influenza viruses are classified into types A, B, and C, the former two of which cause the most human infections. Influenza A (Flu A) is the most common type of influenza virus in humans and is generally responsible for seasonal flu epidemics and potentially pandemics. Flu A viruses can also infect animals such as birds, pigs, and horses. Infections with influenza B (Flu B) virus are generally restricted to humans and less frequently cause epidemics.⁵ Flu A viruses are further divided into subtypes on the basis of two surface proteins: hemagglutinin (H) and neuraminidase (N). Seasonal flu is normally caused by influenza A subtypes H1, H2, H3, N1 and N2.

Respiratory Syncytial Virus (RSV), a member of the *Pneumoviridae* family, consisting of two strains (subgroups A and B) is also the cause of a contagious disease that affects primarily infants, the elderly, and those who are immunocompromised (e.g., patients with chronic lung disease or undergoing treatment for conditions that reduce the strength of their immune system).⁶ The virus can cause both upper respiratory infections, such as colds, and lower respiratory infections manifesting as bronchiolitis and pneumonia.⁶ By the age of two years, most children have already been infected by RSV and because only weak immunity develops, both children and adults can be re-infected.⁶ RSV remains the leading cause for hospitalizations in infants worldwide.⁷ Symptoms appear four to six days after infection and are usually self-limiting, lasting approximately one to two weeks in infants. In adults, infection lasts about 5 days and presents as symptoms consistent with a cold, such as rhinorrhea, fatigue, headache, and fever. The RSV season usually mirrors influenza as infections begin to rise during the fall and last through early spring.^{5,6}

SARS-CoV-2, influenza, and RSV viruses can cause infections that present with very similar symptoms, making clinical differentiation between them very difficult.⁸ Active surveillance programs in conjunction with infection prevention precautions are important components for preventing transmission of SARS-CoV-2, influenza and RSV. The use of assays providing rapid results to identify patients infected with these viruses can be an important factor for effective control, proper choice of treatment, and prevention of widespread outbreaks.

Principle of the Procedure

The Xpert Xpress CoV-2/Flu/RSV *plus* test is an automated *in vitro* diagnostic test for the simultaneous qualitative detection and differentiation of RNA from SARS-CoV-2, Flu A, Flu B, and RSV. The Xpert Xpress CoV-2/Flu/RSV *plus* test is performed on GeneXpert Instrument Systems (GeneXpert system with touchscreen). The primers and probes in the Xpert Xpress CoV-2/Flu/RSV *plus* test are designed to amplify and detect unique sequences in the following: nucleocapsid (N), envelope (E) and RNA-dependent RNA polymerase (RdRP) genes of the SARS-CoV-2 virus genome; matrix (M), basic polymerase (PB2), and acidic protein (PA) segments of the influenza A genome; matrix (M) and non-structural protein (NS) segments of the



influenza B genome; and the nucleocapsid genes of RSV A and RSV B.

The GeneXpert Instrument Systems automate and integrate sample preparation, nucleic acid extraction and amplification, and detection of the target sequences in simple or complex samples using real-time PCR and RT-PCR assays. The systems consist of an instrument, computer, and preloaded software for running tests and viewing the results. The systems require the use of single-use disposable cartridges that hold the RT-PCR reagents and host the RT-PCR process. Because the cartridges are self-contained, cross-contamination between samples is minimized. For a full description of the system, see the *GeneXpert System with Touchscreen Operator Manual*.

The Xpert Xpress CoV-2/Flu/RSV *plus* test includes reagents for the detection of SARS-CoV-2, Flu A, Flu B and RSV viral RNA in either nasopharyngeal swab or anterior nasal swab specimens. A Sample Processing Control (SPC) and a Probe Check Control (PCC) are also included in the cartridge utilized by the GeneXpert instrument. The SPC is present to control for adequate processing of the sample and to monitor for the presence of potential inhibitor(s) in the RT-PCR reaction. The SPC also ensures that the RT-PCR reaction conditions (temperature and time) are appropriate for the amplification reaction and that the RT-PCR reagents are functional. The PCC verifies reagent rehydration, PCR tube filling, and confirms that all reaction components are present in the cartridge including monitoring for probe integrity and dye stability.

The specimen is collected and placed into a transport tube containing 3 mL of viral transport medium (VTM)/Universal Transport Medium (UTM) or 2 mL of eNAT[®]. The specimen is briefly mixed by rapidly inverting the collection tube 5 times. Using the supplied transfer pipette, the sample is transferred to the sample chamber of the Xpert Xpress CoV-2/Flu/RSV *plus* cartridge. The GeneXpert cartridge is loaded onto the GeneXpert instrument, which performs hands-off, automated sample processing, and real-time RT-PCR for detection of viral RNA.

Reagents, Instruments, and Materials

Reagents

Materials Provided

The Xpert Xpress CoV-2/Flu/RSV *plus* kit contains sufficient reagents to process 10 specimens or quality control samples. The kit contains the following:

Xpert Xpress CoV-2/Flu/RSV *plus* Cartridges with Integrated Reaction Tubes 10

- Bead 1, Bead 2, and Bead 3 (freeze-dried) 1 of each per cartridge
- Lysis Reagent 1.0 mL per cartridge
- Binding Reagent 1.0 mL per cartridge
- Elution Reagent 3.0 mL per cartridge
- Wash Reagent 0.4 mL per cartridge

Disposable Transfer Pipettes 12 per kit

Flyer (with instructions to web location) for:

1 per kit

- Assay Definition File (ADF)
- Instructions to import ADF into GeneXpert software
- Instructions for Use

Note Safety Data Sheets (SDS) are available at www.cepheid.com or www.cepheidinternational.com under the **SUPPORT** tab.

Note The bovine serum albumin (BSA) in the beads within this product was produced and manufactured exclusively from bovine plasma sourced in the United States. No ruminant protein or other animal protein was fed to the animals; the animals passed ante- and post-mortem testing. During processing, there was no mixing of the material with other animal materials.



Materials Required but Not Provided

Sample Collection Swabs and Transport Media

Nylon flocked swabs, viral transport medium (VTM), Universal Transport Medium (UTM) and eNAT[®] Molecular Transport Medium are compatible for use with the Xpert Xpress CoV-2/Flu/RSV *plus* test.

The following materials are examples of those that are compatible with the Xpert Xpress CoV-2/Flu/RSV *plus* test:

Nasopharyngeal Sample Collection Kit for Viruses

- Copan UTM[®] 3C057N (Flexible Minitip Flocked Swab with UTM Medium)
- Copan eNAT Molecular Collection and Preservation Medium P/N 6U074S01 (Flexible Minitip Flocked Swab with eNAT Medium)
- BD Becton Dickinson Universal Viral Transport Kit P/N 220531 (Flexible Minitip Flocked Swab with UVT Medium)

Nasal Sample Collection Kit for Viruses

- Copan UTM 3C064N (Regular Flocked Swab with UTM Medium)
- Copan eNAT Molecular Collection and Preservation Medium P/N 6U073S01 (Regular Flocked Swab with eNAT Medium)

Alternatively, swabs and transport media can be obtained separately:

- Nylon flocked swab (Copan P/N 502CS01, 503CS01)
- Viral transport medium, 3 mL (Copan P/N 3C047N, Remel M4RT or Remel M5)

GeneXpert system with touchscreen

GeneXpert instrument, touchscreen unit with built-in scanner, Cepheid OS software version 2.1 or higher, and operator manual

Materials Available but Not Provided

CD – available upon request

- ADF
- Import Instructions for ADF

External controls in the form of inactivated virus(es) are available from ZeptoMetrix (Buffalo, NY) for optional use with the Xpert Xpress CoV-2/Flu/RSV *plus* test.

- External Positive Control – NATtrol Flu/RSV/SARS-CoV-2; Cat # NATFRC-6C-IVD
- External Negative Control – Coxsackievirus A9; Cat # NATCV9-6C-IVD

Warnings and Precautions



General

- For *in vitro* diagnostic use. 
- Positive results are indicative of presence of Flu A, Flu B, RSV, and/or SARS-CoV-2 RNA.
- Positive results for SARS-CoV-2 or suspected novel influenza should be reported to state, local, or federal health departments according to local reporting requirements.
- Treat all biological specimens, including used cartridges, as if capable of transmitting infectious agents. Because it is often impossible to know which might be infectious, all biological specimens should be handled using standard precautions. Guidelines for specimen handling are available from the U.S. Centers for Disease Control and Prevention⁹ and the Clinical and Laboratory Standards Institute.¹⁰
- Follow safety procedures set by your institution for working with chemicals and handling biological specimens.
- Refer to Copan eNAT Package Insert for safety and handling information.
- Avoid direct contact between guanidine thiocyanate and sodium hypochlorite (bleach) or other highly reactive reagents such as acids and bases. These mixtures could release noxious gas.
- Consult your institution's environmental waste personnel on proper disposal of used cartridges, which may contain amplified material. This material may exhibit characteristics of federal EPA Resource Conservation and Recovery Act (RCRA) hazardous waste requiring specific disposal requirements. Check state and local regulations as they may differ from federal disposal regulations. Institutions should check the hazardous waste disposal requirements within their respective countries.
- Biological specimens, transfer devices, and used cartridges should be considered capable of transmitting infectious agents requiring standard precautions. Follow your institution's environmental waste procedures for proper disposal of used cartridges and unused reagents. These materials may exhibit characteristics of chemical hazardous waste requiring specific disposal. If country or regional regulations do not provide clear direction on proper disposal, biological specimens and used cartridges should be disposed per WHO [World Health Organization] medical waste handling and disposal guidelines.
- Used cartridges may contain potentially infectious materials, as well as PCR amplicons. Do not open or attempt to alter any part of the used cartridge for disposal.
- NPS and NS specimens should be collected with appropriate infection control precautions. Refer to the CDC Interim Guidelines for Collecting and Handling of Clinical Specimens for COVID-19 Testing for more information. <https://www.cdc.gov/coronavirus/2019-nCoV/lab/guidelines-clinical-specimens.html>. Viral culture should not be attempted in cases of positive results for SARS-CoV-2 and/or any similar microbial agents, unless a facility with an appropriate level of laboratory biosafety (e.g., BSL 3 and BSL 3+, etc.) is available to receive and culture specimens.
- If infection with a novel Influenza A virus is suspected based on current clinical and epidemiological screening criteria recommended by public health authorities, specimens should be collected with appropriate infection control precautions for novel virulent influenza viruses and sent to state or local health departments for testing. Viral culture should not be attempted in these cases unless a BSL 3+ facility is available to receive and culture specimens.
- Quality control requirements must be performed in conformance with local, state, and/or federal regulations or accreditation requirements and your laboratory's standard quality control procedures.

Specimens

- Maintain proper storage conditions during specimen transport to ensure the integrity of the specimen (see [Specimen Collection, Transport, and Storage](#)). Specimen stability under shipping conditions other than those recommended has not been evaluated.



Assay/Reagent

- Do not open the Xpert Xpress CoV-2/Flu/RSV *plus* cartridge lid except when adding specimen.
- Do not use a cartridge that has been dropped after removing it from the packaging.
- Do not shake the cartridge. Shaking or dropping the cartridge after opening the cartridge lid may yield non-determinate results.

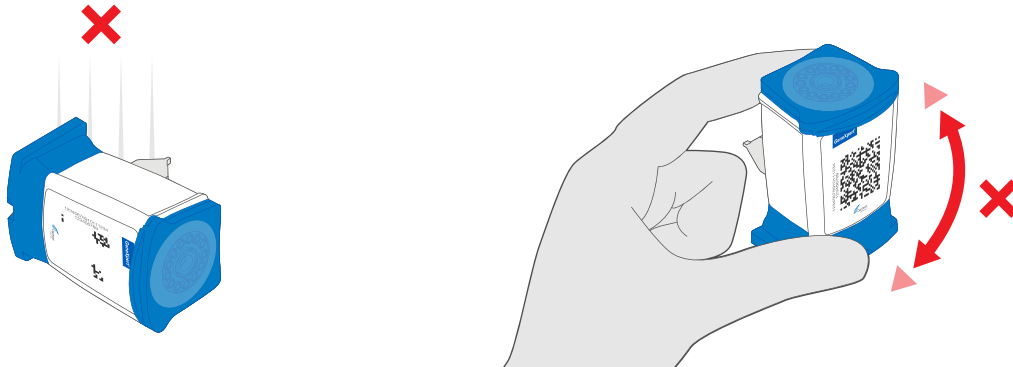

- Do not place the sample ID label on the cartridge lid or on the barcode label on the cartridge.



- Do not use a cartridge with a damaged barcode label.
- Do not use a cartridge that has a damaged reaction tube.
- Do not use reagents beyond their expiry date.
- Each single-use Xpert Xpress CoV-2/Flu/RSV *plus* cartridge is used to process one test. Do not reuse processed cartridges.
- Each single-use disposable pipette is used to transfer one specimen. Do not reuse disposable pipettes.
- Do not use a cartridge if it appears wet or if the lid seal appears to have been broken.
- Wear clean lab coats and gloves. Change gloves between the handling of each specimen.
- In the event of a spill of specimens collected in UTM/VTM or controls, wear gloves and absorb the spill with paper towels. Then, thoroughly clean the contaminated area with a 10% freshly prepared household chlorine bleach. Allow a minimum of two minutes of contact time. Ensure the work area is dry before using 70% denatured ethanol to remove bleach residue. Allow surface to dry completely before proceeding. Or, follow your institution's standard procedures for a contamination or spill event. For equipment, follow the manufacturer's recommendations for decontamination of equipment.
- In the event of spill of specimens collected in Copan eNAT, refer to Copan eNAT Package Insert for proper handling of a spill.



Chemical Hazards, Storage and Handling

Chemical Hazards^{11, 12}

- **Signal Word: Warning**
- **UN GHS Hazard Statements**
 - Harmful if swallowed
 - May be harmful in contact with skin
 - Causes eye irritation
- **UN GHS Precautionary Statements**
 - **Prevention**
 - Wash hands thoroughly after handling.
 - **Response**
 - Call a POISON CENTER or doctor/physician if you feel unwell.
 - If skin irritation occurs: Get medical advice/attention.
 - IF IN EYES: Rinse cautiously with water for several minutes. Remove contact lenses, if present and easy to do. Continue rinsing.
 - If eye irritation persists: Get medical advice/attention.

Storage and Handling

- Store the Xpert Xpress CoV-2/Flu/RSV *plus* cartridges at 2–28 °C.
- Do not open a cartridge lid until you are ready to perform testing.
- Do not use a cartridge that is wet or has leaked.

Specimen Collection, Testing, and Results

Specimen Collection

Specimen Collection, Transport, and Storage

Proper specimen collection, storage, and transport are critical to the performance of this test. Inadequate specimen collection, improper specimen handling and/or transport may yield a false result.

Nasopharyngeal and anterior nasal swab specimens can be stored at room temperature (15–30 °C) for up to 48 hours in VTM/UTM or eNAT until testing is performed on the GeneXpert Instrument Systems. Alternatively, nasopharyngeal and anterior nasal swab specimens can be stored refrigerated (2–8 °C) up to seven days in viral transport medium and up to six days in eNAT until testing is performed on the GeneXpert Instrument Systems.

Nasopharyngeal and anterior nasal swab specimens collected in VTM/UTM or eNAT can be frozen at -20 °C or -80 °C and undergo 1 freeze/thaw cycle.

Procedure

Preparing the Cartridge

 **Important** Start the test within 30 minutes of adding the sample to the cartridge.

1. Remove a cartridge from the package.
2. Check the specimen transport tube is closed.
3. Mix specimen by rapidly inverting the specimen transport tube 5 times. Open the cap on the specimen transport tube.
4. Open the cartridge lid.
5. Remove the transfer pipette from the wrapper.
6. Squeeze the top bulb of the transfer pipette **completely until the top bulb is fully flat**. While continuing to hold the bulb fully flat, place the pipette tip in the specimen transport tube (see [Figure 1](#)).

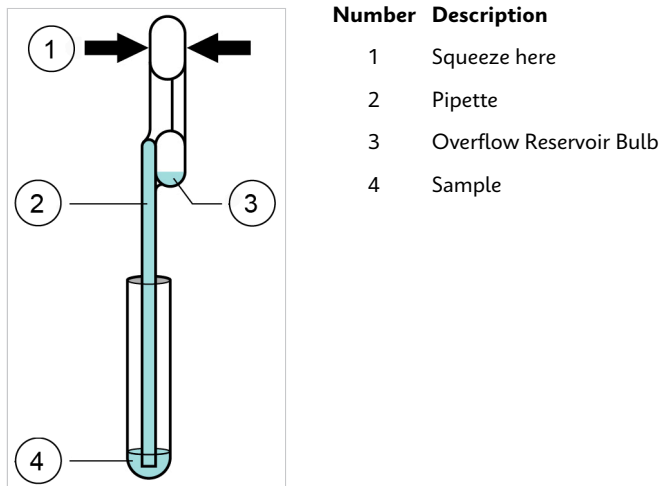

Figure 1 Transfer Pipette

7. Keeping the pipette below the surface of the liquid, release the top bulb of the pipette slowly to fill the pipette with sample before removing from the tube. It is okay if liquid goes into the overflow reservoir (see [Figure 1](#)). Check that the pipette does not contain bubbles.
8. To transfer the sample to the cartridge, squeeze the top bulb of the pipette completely again until it is fully flat to empty the contents of the pipette (300 μ L) into the large opening (Sample Chamber) of the cartridge shown in [Figure 2](#). Some liquid may remain in the overflow reservoir. Dispose of the used pipette.



Figure 2 Xpert Xpress CoV-2/Flu/RSV plus Cartridge

Note Take care to dispense the entire volume of liquid into the Sample Chamber. False negative results may occur if insufficient sample volume is added to the cartridge.

9. Close the cartridge lid.

External Controls

External controls described in [Materials Available but Not Provided](#) are available but not provided and may be used in accordance with local, state, and federal accrediting organizations, as applicable.

To run a control using the Xpert Xpress CoV-2/Flu/RSV plus test, perform the following steps:



1. Mix control by rapidly inverting the external control tube 5 times. Open the cap on external control tube.
2. Open the cartridge lid.
3. Using a clean transfer pipette, transfer one draw of the external control sample (300 μ L) into the large opening (Sample Chamber) in the cartridge shown in [Figure 2](#).
4. Close cartridge lid.

Starting the Test: GeneXpert System with Touchscreen



Important Before you start the test, make sure that:

- The system is running the correct Cepheid OS software version shown in section - **Materials Required but Not Provided**.
- The correct assay definition file is imported into the software.

Note The default workflow is shown. Your system administrator may alter the workflow.

1. Turn on GeneXpert system with touchscreen.
2. Log on to system software using your username and password.
3. On the Modules tab, touch **Start Test**.
4. Follow onscreen prompts to create new test and enter patient and sample information.
5. Scan or manually input the cartridge serial number. If scanning, hold the cartridge about 1-3 inches (3-7 cm) away from the scanner. The scanner projects a green crosshair, which you center on the barcode. Scanning is complete when you hear an audible beep. Touch **Continue**.

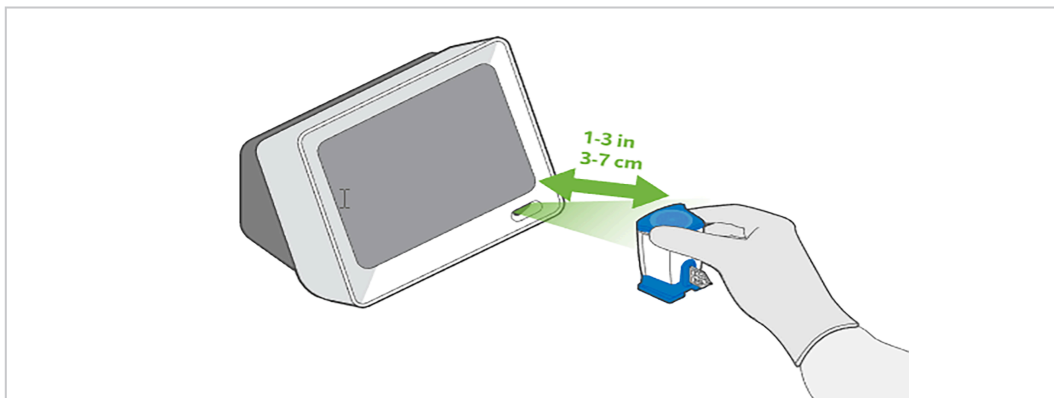

6. Select the desired test and touch **Continue**.
7. Watch the cartridge preparation video, if needed.
8. On the Confirm screen, review all data and touch **Confirm**.
9. Open the module door under flashing green light and insert the cartridge.

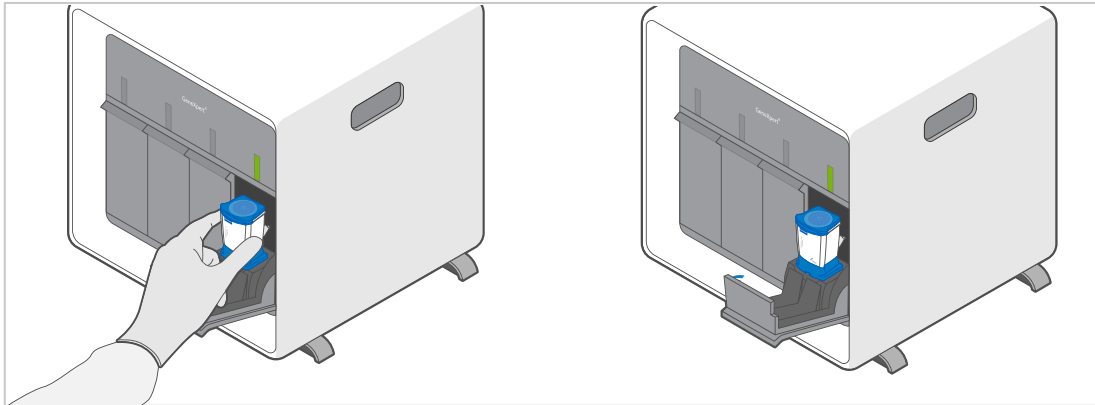

10. Close cartridge module door completely by pressing until it latches. The test starts.

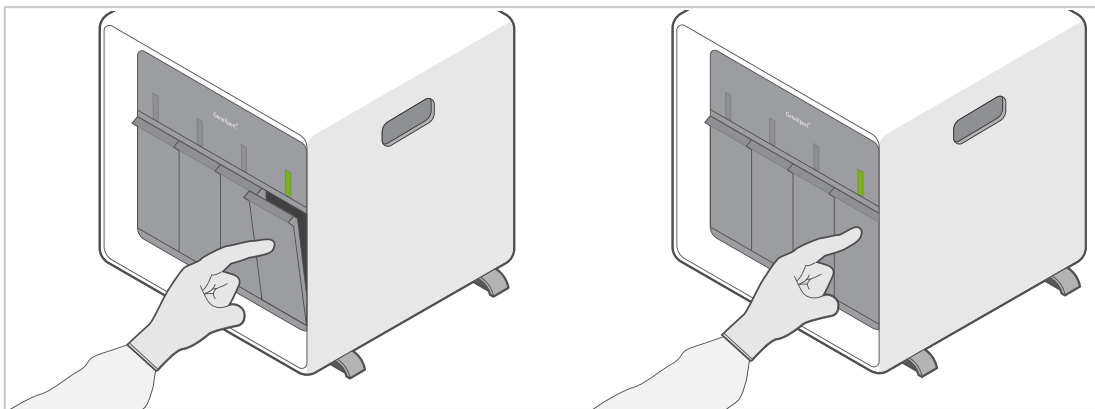

11. When the test completes, the **Results Summary** screen appears. Open the module door and remove cartridge.
12. Dispose of used cartridge in appropriate waste container according to your institution's standard practices.

Viewing Results: GeneXpert System with Touchscreen

The GeneXpert System with Touchscreen results screen will automatically interpret test results for you and clearly show them in the **View Results** window.

1. Tap **Results**.
2. Tap the test to be viewed in the Results screen.
3. Click **OK**.
4. To generate a PDF report file, touch **View Report**. More detailed instructions for viewing and uploading results are available in your system operator manual.

Quality Control

Internal Controls

Each cartridge includes a Sample Processing Control (SPC) and Probe Check Control (PCC).

Sample Processing Control (SPC) – Ensures that the sample was processed correctly. The SPC verifies that



sample processing is adequate. Additionally, this control detects sample-associated inhibition of the real-time PCR assay, ensures that the PCR reaction conditions (temperature and time) are appropriate for the amplification reaction, and that the PCR reagents are functional. The SPC should be positive in a negative sample and can be negative or positive in a positive sample. The SPC passes if it meets the validated acceptance criteria.

Probe Check Control (PCC) – Before the start of the PCR reaction, the GeneXpert System measures the fluorescence signal from the probes to monitor bead rehydration, reaction tube filling, probe integrity, and dye stability. The PCC passes if it meets the validated acceptance criteria.

External Controls

The external quality control materials provided by the specified vendor in [Materials Available but Not Provided](#) are an optional source. All external controls must be used in accordance with local, state, and/or federal regulations or accreditation requirements, as applicable.

Results

The results are interpreted automatically by the GeneXpert system and are clearly shown in the **View Results** window. The Xpert Xpress CoV-2/Flu/RSV *plus* test provides test results based on the detection of respective gene targets according to the algorithms.

The format of the test results presented will vary depending on the user's choice to run one of the following tests:

- Xpress SARS-CoV-2 Flu RSV *plus*
- Xpress SARS-CoV-2 Flu *plus*
- Xpress SARS-CoV-2 *plus*
- Xpress Flu *plus*
- Xpress Flu RSV *plus*

[Table 1](#) shows the possible result outcomes when the **Xpress SARS-CoV-2 Flu RSV *plus*** test mode is selected.

Table 1. Xpress SARS-CoV-2 Flu RSV plus Possible Results and Interpretation

Result	Interpretation
SARS-CoV-2 POSITIVE	<p>The SARS-CoV-2 target RNA is detected.</p> <ul style="list-style-type: none"> • The SARS-CoV-2 signal has a Ct within the valid range and endpoint above the minimum setting. • SPC: NA (not applicable); SPC is ignored because SARS-CoV-2 target amplification occurred. • Probe Check: PASS; all probe check results pass.
Flu A POSITIVE	<p>The Flu A target RNA is detected.</p> <ul style="list-style-type: none"> • The Flu A signal for either the Flu A1 RNA target or the Flu A2 RNA target or signals for both RNA targets have a Ct within the valid range and endpoint above the threshold setting. Note: Flu A1 and Flu A2 are in different channels and a Flu A POSITIVE result requires signals from either one, or both, of the channels). • SPC: NA; SPC is ignored because Flu A target amplification occurred. • Probe Check: PASS; all probe check results pass.



Result	Interpretation
Flu B POSITIVE	<p>The Flu B target RNA is detected.</p> <ul style="list-style-type: none"> The Flu B signal has a Ct within the valid range and endpoint above the minimum setting. SPC: NA; SPC is ignored because Flu B target amplification occurred. Probe Check: PASS; all probe check results pass.
RSV POSITIVE	<p>The RSV target RNA is detected.</p> <ul style="list-style-type: none"> The RSV signal has a Ct within the valid range and endpoint above the minimum setting. SPC: NA; SPC is ignored because RSV target amplification occurred. Probe Check: PASS; all probe check results pass.
SARS- CoV-2 NEGATIVE ; Flu A NEGATIVE ; Flu B NEGATIVE ; RSV NEGATIVE	<p>SARS-CoV-2 target RNA is not detected; Flu A target RNA is not detected; Flu B target RNA is not detected; RSV target RNA is not detected.</p> <ul style="list-style-type: none"> SARS-CoV-2, Flu A, Flu B and RSV target RNAs are not detected. SPC: PASS; SPC has a Ct within the valid range and endpoint above the minimum setting. Probe Check: PASS; all probe check results pass.
INVALID	<p>SPC or other analysis settings do not meet acceptance criteria and all targets are not detected. Repeat test according to the Retest Procedure in Retest Procedure of the IFU.</p> <ul style="list-style-type: none"> SPC: FAIL; SPC and SARS-CoV-2, Flu A, Flu B and RSV signals do not have a Ct within valid range and endpoint is below minimum setting. SARS-CoV-2 amplification fails specification. Probe Check: PASS; all probe check results pass.
ERROR	<p>Presence or absence of SARS-CoV-2, Flu A, Flu B and RSV RNA cannot be determined. Repeat test according to the Retest Procedure in Retest Procedure of the IFU.</p> <ul style="list-style-type: none"> SARS-CoV-2: NO RESULT Flu A: NO RESULT Flu B: NO RESULT RSV: NO RESULT SPC: NO RESULT Probe Check: FAIL¹; all or one of the probe check results fail. <p>¹If the probe check passes, the error is caused by the maximum pressure limit exceeding the acceptable range, no sample added, or by a system component failure.</p>
NO RESULT	<p>Presence or absence of SARS-CoV-2, Flu A, Flu B and RSV RNA cannot be determined. Repeat test according to the Retest Procedure in Retest Procedure of the IFU. A NO RESULT indicates that insufficient data were collected. For example, the operator stopped a test that was in progress.</p> <ul style="list-style-type: none"> SARS-CoV-2: NO RESULT Flu A: NO RESULT Flu B: NO RESULT RSV: NO RESULT SPC: NO RESULT Probe Check: NA

Table 2 shows the possible result outcomes when the **Xpress SARS-CoV-2 Flu plus** test mode is selected.



Table 2. Xpress SARS-CoV-2 Flu plus Possible Results and Interpretation

Result	Interpretation
SARS-CoV-2 POSITIVE	<p>The SARS-CoV-2 target RNA is detected.</p> <ul style="list-style-type: none"> The SARS-CoV-2 signal has a Ct within the valid range and endpoint above the minimum setting. SPC: NA; SPC is ignored because SARS-CoV-2 target amplification occurred. Probe Check: PASS; all probe check results pass.
Flu A POSITIVE	<p>The Flu A target RNA is detected.</p> <ul style="list-style-type: none"> The Flu A signal for either the Flu A1 RNA target or the Flu A2 RNA target or signals for both RNA targets has a Ct within the valid range and endpoint above the threshold setting. (Note: Flu A1 and Flu A2 are in different channels and a Flu A POSITIVE result requires signals from either one, or both, of the channels). SPC: NA; SPC is ignored because Flu A target amplification occurred. Probe Check: PASS; all probe check results pass.
Flu B POSITIVE	<p>The Flu B target RNA is detected.</p> <ul style="list-style-type: none"> The Flu B signal has a Ct within the valid range and endpoint above the minimum setting. SPC: NA; SPC is ignored because Flu B target amplification occurred. Probe Check: PASS; all probe check results pass.
SARS-CoV-2 NEGATIVE ; Flu A NEGATIVE ; Flu B NEGATIVE	<p>SARS-CoV-2 target RNA is not detected; Flu A target RNA is not detected; Flu B target RNA is not detected.</p> <ul style="list-style-type: none"> SARS-CoV-2, Flu A and Flu B target RNAs are not detected SPC: PASS; SPC has a Ct within the valid range and endpoint above the minimum setting Probe Check: PASS; all probe check results pass
INVALID	<p>SPC or other analysis settings do not meet acceptance criteria and SARS-CoV-2, Flu A and Flu B are not detected. Repeat test according to the Retest Procedure in Retest Procedure of the IFU.</p> <ul style="list-style-type: none"> SPC: FAIL; SPC and SARS-CoV-2, Flu A and Flu B signals do not have a Ct within valid range and endpoint is below minimum setting. SARS-CoV-2 amplification fails specification. Probe Check: PASS; all probe check results pass
ERROR	<p>Presence or absence of SARS-CoV-2, Flu A and Flu B RNA cannot be determined. Repeat test according to the Retest Procedure in Retest Procedure of the IFU.</p> <ul style="list-style-type: none"> SARS-CoV-2: NO RESULT Flu A: NO RESULT Flu B: NO RESULT SPC: NO RESULT Probe Check: FAIL¹; all or one of the probe check results fail <p>¹ If the probe check passes, the error is caused by the maximum pressure limit exceeding the acceptable range, no sample added, or by a system component failure.</p>
NO RESULT	<p>Presence or absence of SARS-CoV-2, Flu A and Flu B RNA cannot be determined. Repeat test according to the Retest Procedure in Retest Procedure of the IFU. A NO RESULT indicates that insufficient data were collected. For example, the operator stopped a test that was in progress.</p> <ul style="list-style-type: none"> SARS-CoV-2: NO RESULT Flu A: NO RESULT Flu B: NO RESULT SPC: NO RESULT Probe Check: NA

Table 3 shows the possible result outcomes when the **Xpress SARS-CoV-2 plus** test mode is selected.

**Table 3. Xpress SARS-CoV-2 plus Possible Results and Interpretation**

Result	Interpretation
SARS-CoV-2 POSITIVE	<p>The SARS-CoV-2 target RNA is detected.</p> <ul style="list-style-type: none"> • The SARS-CoV-2 signal has a Ct within the valid range and endpoint above the minimum setting. • SPC: NA; SPC is ignored because SARS-CoV-2 target amplification occurred. • Probe Check: PASS; all probe check results pass.
SARS-CoV-2 NEGATIVE	<p>SARS-CoV-2 target RNA is not detected.</p> <ul style="list-style-type: none"> • SARS-CoV-2 target RNA is not detected. • SARS-CoV-2 amplification fails specification. • SPC: PASS; SPC has a Ct within the valid range and endpoint above the minimum setting. • Probe Check: PASS; all probe check results pass.
INVALID	<p>SPC or other analysis settings do not meet acceptance criteria and SARS-CoV-2 is not detected. Repeat test according to the Retest Procedure in Retest Procedure of the IFU.</p> <ul style="list-style-type: none"> • SPC: FAIL; SPC and SARS-CoV-2 signals do not have a Ct within valid range and endpoint is below minimum setting. • SARS-CoV-2 amplification fails specification. • Probe Check: PASS; all probe check results pass.
ERROR	<p>Presence or absence of SARS-CoV-2 RNA cannot be determined. Repeat test according to the Retest Procedure in Retest Procedure of the IFU.</p> <ul style="list-style-type: none"> • SPC: NO RESULT • SARS-CoV-2: NO RESULT • Probe Check: FAIL¹; all or one of the probe check results fail. <p>¹ If the probe check passes, the error is caused by the maximum pressure limit exceeding the acceptable range, no sample added, or by a system component failure.</p>
NO RESULT	<p>Presence or absence of SARS-CoV-2 RNA cannot be determined. Repeat test according to the Retest Procedure in Retest Procedure of the IFU. A NO RESULT indicates that insufficient data were collected. For example, the operator stopped a test that was in progress.</p> <ul style="list-style-type: none"> • SARS-CoV-2: NO RESULT • SPC: NO RESULT • Probe Check: NA

Table 4 shows the possible result outcomes when the **Xpress Flu plus** test mode is selected.

Table 4. Xpress Flu plus Possible Results and Interpretation

Result	Interpretation
FLU A POSITIVE	<p>The Flu A target RNA is detected.</p> <ul style="list-style-type: none"> • The Flu A signal for either the Flu A1 RNA target or the Flu A2 RNA target or signals for both RNA targets have a Ct within the valid range and endpoint above the threshold setting. (Note: Flu A1 and Flu A2 are in different channels and a Flu A POSITIVE result requires signals from either one, or both, of the channels). • SPC – NA; SPC is ignored as Flu A target amplification occurred. • Probe Check: PASS; all probe check results pass.
FLU B POSITIVE	<ul style="list-style-type: none"> • The Flu B target RNA is detected. • The Flu B signal has a Ct within the valid range and endpoint above the minimum setting. • SPC: NA; SPC is ignored as Flu B target amplification occurred. • Probe Check: PASS; all probe check results pass.



Result	Interpretation
FLU A NEGATIVE; FLU B NEGATIVE	<p>Flu A target RNA is not detected; Flu B target RNA is not detected.</p> <ul style="list-style-type: none"> Flu A and Flu B target RNAs are not detected. SPC: PASS; SPC has a Ct within the valid range and endpoint above the minimum setting. Probe Check: PASS; all probe check results pass.
INVALID	<p>SPC does not meet acceptance criteria, and Flu A and Flu B are not detected. Repeat test according to the Retest Procedure in Retest Procedure.</p> <ul style="list-style-type: none"> SPC: FAIL; SPC, Flu A, and Flu B signals do not have a Ct within valid range and endpoint is below minimum setting. Probe Check: PASS; all probe check results pass.
ERROR	<p>Presence or absence of Flu A and Flu B cannot be determined. Repeat test according to the Retest Procedure in Retest Procedure.</p> <ul style="list-style-type: none"> Flu A: NO RESULT Flu B: NO RESULT SPC: NO RESULT Probe Check: FAIL¹; all or one of the probe check results fail. <p>¹ If the probe check passes, the error is caused by the maximum pressure limit exceeding the acceptable range, no sample added, or by a system component failure.</p>
NO RESULT	<p>Presence or absence of Flu A, and Flu B RNA cannot be determined. Repeat test according to the Retest Procedure in Retest Procedure. A NO RESULT indicates that insufficient data were collected. For example, the operator stopped a test that was in progress.</p> <ul style="list-style-type: none"> Flu A: NO RESULT Flu B: NO RESULT SPC: NO RESULT Probe Check: NA

Table 5 shows the possible result outcomes when the **Xpress Flu RSV** test mode is selected.

Table 5. Xpress Flu RSV Possible Results and Interpretation

Result	Interpretation
FLU A POSITIVE	<p>The Flu A target RNA is detected.</p> <ul style="list-style-type: none"> The Flu A signal for either the Flu A1 RNA target or the Flu A2 RNA target or signals for both RNA targets have a Ct within the valid range and endpoint above the threshold setting. (Note: Flu A1 and Flu A2 are in different channels and a Flu A POSITIVE result requires signals from either one, or both, of the channels). SPC – NA; SPC is ignored as Flu A target amplification occurred. Probe Check: PASS; all probe check results pass.
FLU B POSITIVE	<p>The Flu B target RNA is detected.</p> <ul style="list-style-type: none"> The Flu B signal has a Ct within the valid range and endpoint above the minimum setting. SPC: NA; SPC is ignored as Flu B target amplification occurred. Probe Check: PASS; all probe check results pass.
RSV POSITIVE	<p>The RSV target RNA is detected.</p> <ul style="list-style-type: none"> The RSV signal has a Ct within the valid range and endpoint above the minimum setting. SPC: NA; SPC is ignored as RSV target amplification occurred. Probe Check: PASS; all probe check results pass.



Result	Interpretation
FLU A NEGATIVE; FLU B NEGATIVE; RSV NEGATIVE	Flu A target RNA is not detected; Flu B target RNA is not detected; RSV target RNA is not detected. <ul style="list-style-type: none"> Flu A, Flu B and RSV target RNAs are not detected. SPC: PASS; SPC has a Ct within the valid range and endpoint above the minimum setting. Probe Check: PASS; all probe check results pass.
INVALID	SPC does not meet acceptance criteria and Flu A, Flu B and RSV are not detected. Repeat test according to the Retest Procedure in Retest Procedure . <ul style="list-style-type: none"> SPC: FAIL; SPC, Flu A, Flu B and RSV signals do not have a Ct within valid range and endpoint is below minimum setting. Probe Check: PASS; all probe check results pass.
ERROR	Presence or absence of Flu A, Flu B and RSV cannot be determined. Repeat test according to the Retest Procedure in Retest Procedure . <ul style="list-style-type: none"> Flu A: NO RESULT Flu B: NO RESULT SPC: NO RESULT Probe Check: FAIL¹; all or one of the probe check results fail. <p>¹ If the probe check passes, the error is caused by the maximum pressure limit exceeding the acceptable range, no sample added, or by a system component failure.</p>
NO RESULT	Presence or absence of Flu A, and Flu B RNA cannot be determined. Repeat test according to the Retest Procedure in Retest Procedure . A NO RESULT indicates that insufficient data were collected. For example, the operator stopped a test that was in progress. <ul style="list-style-type: none"> Flu A: NO RESULT Flu B: NO RESULT RSV: NO RESULT SPC: NO RESULT Probe Check: NA

The **Xpress SARS-CoV-2 plus** and **Xpress Flu plus** test modes include an Early Assay Termination (EAT) function that will provide earlier time to result in high titer specimens if the signal from the SARS-CoV-2 or Flu A/B target reaches a predetermined threshold before all PCR cycles have been completed. When SARS-CoV-2 or Flu A/B titers are high enough to initiate the EAT function, the SPC and/or other target amplification curves may not be seen, and their results may not be reported.

Reasons to Repeat the Test

- If any of the test results mentioned below occur, repeat the test once according to instructions in [Retest Procedure](#).
 - An **INVALID** result indicates that the control SPC failed. The sample was not properly processed, PCR is inhibited, or the sample was not properly collected. Alternatively, other assay analysis settings intended to produce a valid test result were not met.
 - An **ERROR** result could be due to, but not limited to, Probe Check Control failure, system component failure, no sample added, or the maximum pressure limits were exceeded.
 - A **NO RESULT** indicates that insufficient data were collected. For example, cartridge failed integrity test, the operator stopped a test that was in progress, or a power failure occurred.
- If an External Control fails to perform as expected, repeat external control test and/or contact Cepheid Technical Support for assistance.
- Because of the incidence of co-infection with three or more viruses (Influenza A, Influenza B, RSV and



SARS-CoV-2) is low, it is recommended that specimens undergo repeat testing if nucleic acids from three or more viruses are detected in a single specimen. Repeat testing according to the instructions in [Retest Procedure](#).

Retest Procedure

To retest a non-determinate result (**INVALID**, **NO RESULT**, or **ERROR**), use a new cartridge.

Use the leftover sample from the original specimen transport medium tube or new external control tube.

1. Put on a clean pair of gloves. Obtain a new Xpert Xpress CoV-2/Flu/RSV *plus* cartridge and a new transfer pipette.
2. Check the specimen transport tube or external control tube is closed.
3. Mix the sample by rapidly inverting the specimen transport medium tube or external control tube 5 times. Open the cap on the specimen transport tube or external control tube.
4. Open the cartridge lid.
5. Using a clean transfer pipette (supplied), transfer sample (one draw) to the sample chamber with the large opening in the cartridge.
6. Close the cartridge lid.

Limitations

Limitations of the Procedure

- Performance of the Xpert Xpress CoV-2/Flu/RSV *plus* test has only been established in nasopharyngeal swab and anterior nasal swab specimens. Use of the Xpert Xpress CoV-2/Flu/RSV *plus* test with other specimen types has not been assessed and performance characteristics are unknown.
- The performance of the Xpert Xpress CoV-2/Flu/RSV *plus* test has not been specifically evaluated for nasopharyngeal swab and anterior nasal swab specimens from immunocompromised individuals.
- The clinical performance has not been established for all circulating variants of SARS-CoV-2 but is anticipated to be reflective of the prevalent variants in circulation at the time and location of the clinical evaluation. Performance at the time of testing may vary depending on the variants circulating, including newly emerging strains of SARS-CoV-2 and their prevalence, which change over time.
- Performance characteristics for influenza A were established when influenza A/H3 and influenza A/H1-2009 were the predominate influenza strains. When other influenza A viruses are emerging, performance characteristics may differ.
- As with any molecular test, mutations within the target regions of the Xpert Xpress CoV-2/Flu/RSV *plus* test could affect primer and/or probe binding resulting in failure to detect the presence of target viruses or newly emerging variants.
- Positive and negative predictive values are highly dependent on prevalence. The likelihood of a negative result being false is higher during peak activity when prevalence of disease is high. The likelihood of a positive result being false is higher during periods when prevalence is moderate to low.
- This test cannot rule out diseases caused by non-target bacterial or viral pathogens.
- The performance of this test was validated using the procedures provided in this package insert only. Modifications to these procedures may alter the performance of the test.
- Erroneous test results might occur from improper specimen collection; failure to follow the recommended



sample collection, handling, and storage procedures; technical error; or sample mix-up. Careful compliance with the instructions in this insert is necessary to avoid erroneous results.

- When using the Xpert Xpress CoV-2/Flu/RSV *plus* test in the Flu Only mode, in the event of a mixed Flu A and Flu B infection where one target crosses the cycle threshold >5 cycles prior to the other target, the target with the higher titer of the two infections will be reported as POSITIVE and the lower titer target will be reported as NEGATIVE.
- False negative results may occur if on-panel viruses are present at levels below the analytical limit of detection.
- Negative results do not preclude SARS-CoV-2, influenza A, influenza B, or RSV infections and should not be used as the sole basis for diagnosis, treatment, or other patient management decisions.
- Use of this test is limited to personnel who are trained in the procedure. Failure to follow these instructions may result in erroneous results. Results from the Xpert Xpress CoV-2/Flu/RSV *plus* test should be correlated with the clinical history, epidemiological data, and other data available to the clinician evaluating the patient.
- Viral nucleic acid may persist *in vivo*, independent of virus infectivity. Detection of analyte target(s) does not imply that the corresponding virus(es) are infectious or are the causative agents for clinical symptoms.
- This test has been evaluated for use with human specimen material only.
- The Xpert Xpress CoV-2/Flu/RSV *plus* test is a qualitative test that reports Ct values for individuals that test positive for SARS-CoV-2, influenza A, influenza B, and/or RSV. These Ct values should not be interpreted as a measure of viral levels.
- The performance of this test has not been established for monitoring treatment of infection with any of the on-panel organisms. The performance of this test has not been established with postmortem specimens.
- The Xpert Xpress CoV-2/Flu/RSV *plus* test has not been validated for the testing of pooled specimens or the screening of specimens from asymptomatic individuals that do not have signs and symptoms of respiratory infection.
- The performance of this test has not been established in screening of blood or blood products.
- Anterior nasal swab and nasopharyngeal swab specimens collected in 2 mL Copan eNAT, Remel M4RT, and Remel M5 are compatible for use with the Xpert Xpress CoV-2/Flu/RSV *plus* test. Performance of the Xpert Xpress CoV-2/Flu/RSV *plus* test with specimens collected in Copan eNAT, Remel M4RT and Remel M5 has been established in analytical studies, however, clinical performance of the assay in these media types was not established.
- The effect of interfering substances has only been evaluated for those listed within the labeling. Interference by substances other than those described may lead to erroneous results.
- FluMist was shown to interfere with detection of low levels of SARS-CoV-2 and RSV B at concentrations $>6.7 \times 10^{-6}$ % (v/v) and was shown to interfere with detection of low levels of RSV A at concentrations $>6.7 \times 10^{-7}$ % (v/v).
- Recent patient exposure to FluMist[®] or other live attenuated influenza vaccines may cause inaccurate positive influenza results.
- Human peripheral blood mononuclear cells (PBMC) at concentrations $> 2.5 \times 10^5$ cells/mL were shown to interfere with detection of low levels of influenza B.
- Snuff at $> 0.25\%$ (w/v) was shown to interfere with the detection of low levels of influenza A and at $> 0.1\%$ (w/v) with the detection of low levels of influenza B.
- Zicam at 15% (w/v) was shown to interfere with the detection of low levels of influenza A, influenza B and RSV A.
- Results from analytical studies with contrived co-infected samples showed potential for competitive interference of influenza B or RSV A at low concentrations ($\sim 3 \times \text{LoD}$) when influenza A concentration is $> 1.7 \times 10^5$ RNA copies/mL or 1.7×10^6 RNA copies/mL, respectively. In addition, there is potential for competitive



interference of influenza B at low concentration (~3x LoD) when SARS-CoV-2 concentration is >1e5 RNA copies/mL.

- Cross-reactivity with respiratory tract organisms other than those described herein may lead to erroneous results.
- As the Xpert Xpress CoV-2/Flu/RSV *plus* test does not differentiate between the N, RdRP and E gene targets, the presence of other coronaviruses in the B lineage, *Betacoronavirus* genus, including SARS-CoV and bat coronaviruses may cause a false positive result. None of these other coronaviruses are known to currently circulate in the human population.
- The RSV A primers and probes have a high degree of identity to Pangolin RSV A sequences and therefore may cross-react with Pangolin RSV A if the organism is circulating in a human population and present in a sample tested with the Xpert Xpress CoV-2/Flu/RSV *plus* test. None of these Pangolin RSV A strains are known to currently circulate in the human population.
- This test is not intended to differentiate RSV subgroups (i.e., A or B), influenza A subtypes (i.e., H1N1, H3N2) or influenza B lineages (i.e., Yamagata, Victoria). If differentiation of specific RSV or influenza subtypes and strains is needed, additional testing, in consultation with state or local public health departments, is required.
- Analysis settings may trigger an **INVALID** result (with error 5015) to reduce the risk of false positive results caused by non-specific or irregular fluorescence detection during PCR and could occur for some samples with very high SARS-CoV-2 viral concentrations.

Expected Values

Expected values as determined by Xpert Xpress CoV-2/Flu/RSV *plus* are presented for Category I and II specimens, stratified by nasopharyngeal swab (NPS) and anterior nasal swab (NS) specimen types (Table 6) and by age group (Table 7).

Table 6. Positivity Rate Stratified by Specimen Type for Category I and II Specimens

Target	Prospectively Collected Fresh and Frozen Specimens ^a from 2022 (Category I and Category II)			Prospectively Collected Frozen Specimens ^b from 2016-2017 Influenza Season (Category II)		
	Overall	NPS	NS	Overall	NPS	NS
SARS-CoV-2	19.2% (971/5051)	19.7% (499/2536)	18.8% (472/2515)	N/A ^c	N/A ^c	N/A ^c
Flu A	4.8% (250/5172)	4.3% (111/2593)	5.4% (139/2579)	22.9% (179/782)	24.9% (104/418)	20.6% (75/364)
Flu B	0.0% (0/5172)	0.0% (0/2593)	0.0% (0/2579)	12.0% (94/782)	13.6% (57/418)	10.2% (37/364)
RSV	0.5% (26/5172)	0.5% (12/2593)	0.5% (14/2579)	14.6% (114/782)	14.1% (59/418)	15.1% (55/364)

- A small number (N=59; 1.1%) of the prospectively collected specimens were frozen and retrospectively tested.
- Prospectively collected and stored thereafter at -70°C.
- Specimens collected prior to the COVID-19 pandemic were expected to be negative for SARS-CoV-2 and were tested only for the Flu A, Flu B, and RSV targets.

**Table 7. Positivity Rate Stratified by Age Group for Category I and II Specimens**

Target	Prospectively Collected Fresh and Frozen Specimens ^a from 2022 (Category I and Category II)					Prospectively Collected Frozen Specimens ^b from 2016-2017 Influenza Season (Category II)				
	Overall	Age Group (years)				Overall	Age Group (years)			
		≤5	6-21	22-59	≥60		≤5	6-21	22-59	≥60
SARS-CoV-2	19.2% (971/5051)	11.3% (21/186)	13.8% (152/1099)	21.7% (667/3076)	19.0% (131/690)	N/A ^c	N/A ^c	N/A ^c	N/A ^c	N/A ^c
Flu A	4.8% (250/5172)	6.6% (12/181)	9.2% (104/1136)	3.8% (119/3152)	2.1% (15/703)	22.9% (179/782)	18.4% (56/305)	40.4% (63/156)	16.1% (39/242)	26.6% (21/79)
Flu B	0.0% (0/5172)	0.0% (0/181)	0.0% (0/1136)	0.0% (0/3152)	0.0% (0/703)	12.0% (94/782)	10.2% (31/305)	19.2% (30/156)	12.0% (29/242)	5.1% (4/79)
RSV	0.5% (26/5172)	1.1% (2/181)	0.7% (8/1136)	0.5% (15/3152)	0.1% (1/703)	14.6% (114/782)	30.8% (94/305)	0.6% (1/156)	3.7% (9/242)	12.7% (10/79)

- a. A small number (N=59; 1.1%) of the prospectively collected specimens were frozen and retrospectively tested.
- b. Prospectively collected and stored thereafter at -70°C.
- c. Specimens collected prior to the COVID-19 pandemic were expected to be negative for SARS-CoV-2 and were tested only for the Flu A, Flu B, and RSV targets.

! Specific Performance Characteristics

Clinical Performance

Clinical Evaluation

The clinical performance of the Xpert Xpress CoV-2/Flu/RSV *plus* test was evaluated in a multi-site, observational and method comparison study that included 33 geographically diverse sites in the United States (US) using specimens collected from individuals showing signs and symptoms of respiratory infection. Of the 33 sites, 5 sites participated in specimen collection only, 27 performed Xpert testing and specimen collection, and 1 site performed Xpert testing as well as comparator and discrepant testing.

Specimens tested included prospective clinical NPS and NS specimens collected in UTM/VTM. Prospectively collected fresh clinical specimens (Category I) tested in the study were from a larger US specimen collection protocol. Fresh (98.9%) and frozen (1.1%) specimens meeting the eligibility criteria were prospectively collected and tested in 2022. Due to low prevalence of Flu/RSV in 2022, archived prospectively collected frozen clinical specimens (Category II) collected during the 2016-2017 influenza season were used to supplement the sample size. These specimens represent contemporary Flu/RSV strains. Since these specimens were collected prior to the COVID-19 pandemic, they were expected to be negative for SARS-CoV-2 and therefore tested only for the Flu A, Flu B, and RSV targets. Available demographic data from the individuals from whom Category I and Category II specimens were collected are presented in [Table 8](#).

Table 8. Demographic Summary for Category I and II Specimens

Prospectively Collected Fresh and Frozen Specimens from 2022 (Category I)	NPS (N=2672)	NS (N=2659)	Overall (N=5331)
Gender			
Female	1568 (58.7%)	1634 (61.5%)	3202 (60.1%)
Male	1104 (41.3%)	1025 (38.5%)	2129 (39.9%)
Age Group (Years)			
≤5	9 (0.3%)	183 (6.9%)	192 (3.6%)
6-21	623 (23.3%)	562 (21.1%)	1185 (22.2%)
22-59	1676 (62.7%)	1553 (58.4%)	3229 (60.6%)



Prospectively Collected Fresh and Frozen Specimens from 2022 (Category I)	NPS (N=2672)	NS (N=2659)	Overall (N=5331)
≥60	364 (13.6%)	361 (13.6%)	725 (13.6%)
Race			
American Indian or Alaska Native	5 (0.2%)	6 (0.2%)	11 (0.2%)
Asian	73 (2.7%)	80 (3.0%)	153 (2.9%)
Asian, White	8 (0.3%)	1 (0.0%)	9 (0.2%)
Black or African American	734 (27.5%)	730 (27.5%)	1464 (27.5%)
Black or African American, White	10 (0.4%)	12 (0.5%)	22 (0.4%)
Native Hawaiian or Other Pacific Islander	6 (0.2%)	2 (0.1%)	8 (0.2%)
Other Mixed (N ≤ 3)	4 (0.1%)	5 (0.2%)	9 (0.2%)
White	1685 (63.1%)	1641 (61.7%)	3326 (62.4%)
Participant Declined to Answer, or Unknown	147 (5.5%)	182 (6.8%)	329 (6.2%)
Ethnicity			
Hispanic	228 (8.5%)	213 (8.0%)	441 (8.3%)
Non-Hispanic	2333 (87.3%)	2323 (87.4%)	4656 (87.3%)
Participant Declined to Answer, or Unknown	111 (4.2%)	123 (4.6%)	234 (4.4%)
Specimen Testing			
Fresh	2641 (98.8%)	2631 (98.9%)	5272 (98.9%)
Frozen	31 (1.2%)	28 (1.1%)	59 (1.1%)
COVID-19 Vaccination Status			
Vaccinated	1969 (73.7%)	1865 (70.1%)	3834 (71.9%)
Not Vaccinated	665 (24.9%)	764 (28.7%)	1429 (26.8%)
Unknown	38 (1.4%)	30 (1.1%)	68 (1.3%)
Testing Environment			
CLIA Waiver	1603 (60.0%)	1619 (60.9%)	3222 (60.4%)
Laboratory/NPT	1069 (40.0%)	1040 (39.1%)	2109 (39.6%)
Prospectively Collected Frozen Specimens from 2016-2017 Influenza Season (Category II)	NPS Collected from One Nostril (N=422)	NS Collected from Both Nostrils (N=368)	Overall (N=790)
Gender			
Female	211 (50.0%)	223 (60.6%)	434 (54.9%)
Male	211 (50.0%)	145 (39.4%)	356 (45.1%)
Age Group (Years)			
≤5	164 (38.9%)	144 (39.1%)	308 (39.0%)
6-21	85 (20.1%)	72 (19.6%)	157 (19.9%)
22-59	134 (31.8%)	111 (30.2%)	245 (31.0%)
≥60	39 (9.2%)	41 (11.1%)	80 (10.1%)



Specimens were tested using Xpert Xpress CoV-2/Flu/RSV *plus* side-by-side with a U.S. FDA-cleared molecular respiratory panel that includes SARS-CoV-2 and a U.S. FDA-cleared molecular Flu A/B//RSV test, in a randomized and blinded fashion.

Positive Percent Agreement (PPA) and Negative Percent Agreement (NPA), and non-determinate rate were determined by comparing the results of the Xpert Xpress CoV-2/Flu/RSV *plus* test relative to the results of a U.S. FDA-cleared molecular respiratory panel for the SARS-CoV-2 target, and a U.S. FDA-cleared molecular Flu A/B/RSV assay for the Flu A, Flu B, and RSV targets, respectively.

Discrepant results between Xpert Xpress CoV-2/Flu/RSV *plus* and the comparator for the SARS-CoV-2 target were investigated using a U.S. FDA EUA SARS-CoV-2 molecular test. Discrepant results between the Xpert Xpress CoV-2/Flu/RSV *plus* and the comparator for the Flu A/B/RSV targets were investigated using a U.S. FDA-cleared molecular respiratory panel.

A total of 5051 specimens, including 2536 NPS and 2515 NS specimens that yielded valid results by both the Xpert Xpress CoV-2/Flu/RSV *plus* and the U.S. FDA-cleared molecular respiratory panel, were included in the performance evaluation for SARS-CoV-2. A total of 5954 specimens, including 3011 NPS and 2943 NS specimens that yielded valid results by both the Xpert Xpress CoV-2/Flu/RSV *plus* and the U.S. FDA-cleared molecular Flu A/B/RSV assay were included in the performance evaluation for Flu A, Flu B, and RSV targets.

For the NPS specimens (both fresh and frozen specimens, combined), Xpert Xpress CoV-2/Flu/RSV *plus* demonstrated a PPA and NPA of 97.1% and 98.2% for SARS-CoV-2, respectively; 99.0% and 99.1% for Flu A, respectively; 96.6% and 100.0% for Flu B, respectively; 98.6% and 100.0% for RSV, respectively ([Table 9](#)). The initial non-determinate rate for the Xpert Xpress CoV-2/Flu/RSV *plus* test was 2.4% (74/3094). On repeat testing, 66 specimens yielded valid results. The final non-determinate rate for the Xpert Xpress CoV-2/Flu/RSV *plus* test was 0.3% (8/3094).



Table 9. Xpert Xpress CoV-2/Flu/RSV plus Performance Results for NPS Specimens

Target	Specimen Collection	Numbers of Specimens	True Positive	False Positive	True Negative	False Negative	PPA (%)	95% two-sided Confidence Interval	NPA (%)	95% two-sided Confidence Interval
SARS-CoV-2	Fresh	2505	454	37 ^a	2000	14 ^b	97	95.0 - 98.2	98.2	97.5 - 98.7
	Frozen	31	8	0	23	0	100	67.6 - 100.0	100	85.7 - 100.0
	Overall	2536	462	37	2023	14	97.1	95.1 - 98.2	98.2	97.5 - 98.7
Flu A	Fresh	2562	98	11 ^c	2451	2 ^d	98	93.0 - 99.5	99.6	99.2 - 99.8
	Frozen	449	93	13 ^e	343	0	100	96.0 - 100.0	96.3	93.9 - 97.9
	Overall	3011	191	24	2794	2	99.0	96.3 - 99.7	99.1	98.7 - 99.4
Flu B	Fresh	2562	0	0	2562	0	NA	NA	100	99.9 - 100.0
	Frozen	449	57	0	390	2 ^f	96.6	88.5 - 99.1	100	99.0 - 100.0
	Overall	3011	57	0	2952	2	96.6	88.5 - 99.1	100	99.9 - 100.0
RSV	Fresh	2562	12	0	2550	0	100	75.8 - 100.0	100	99.8 - 100.0
	Frozen	449	59	0	389	1 ^g	98.3	91.1 - 99.7	100	99.0 - 100.0
	Overall	3011	71	0	2939	1	98.6	92.5 - 99.8	100	99.9 - 100.0

- a. Discrepant test results based on a U.S. FDA EUA SARS-CoV-2 molecular test: 15/37 SARS-CoV-2 positive; 22/37 SARS-CoV-2 negative
- b. Discrepant test results based on a U.S. FDA EUA SARS-CoV-2 molecular test: 3/14 SARS-CoV-2 positive; 10/14 SARS-CoV-2 negative; 1/14 invalid result
- c. Discrepant test results based on a U.S. FDA-cleared molecular respiratory panel: 8/11 Flu A positive; 3/11 Flu A negative
- d. Discrepant test results based on a U.S. FDA-cleared molecular respiratory panel: 1/2 Flu A positive; 1/2 Flu A negative
- e. Discrepant test results based on a U.S. FDA-cleared molecular respiratory panel: 13/13 tests not performed due to specimens being stored for a longer duration than recommended per the package insert
- f. Discrepant test results based on a U.S. FDA-cleared molecular respiratory panel: 2/2 tests not performed due to specimens being stored for a longer duration than recommended per the package insert
- g. Discrepant test results based on a U.S. FDA-cleared molecular respiratory panel: 1/1 test not performed due to specimens being stored for a longer duration than recommended per the package insert

For the NS specimens (both fresh and frozen specimens, combined), Xpert Xpress CoV-2/Flu/RSV plus demonstrated a PPA and NPA of 98.2% and 98.8% for SARS CoV-2, respectively; 98.0% and 99.3% for Flu A, respectively; 100.0% and 99.9% for Flu B, respectively; 95.8% and 100.0% for RSV, respectively (Table 10). The initial non-determinate rate for the Xpert Xpress CoV-2/Flu/RSV plus test was 2.4% (74/3027). On repeat testing, 57 specimens gave valid results upon retest. The final non-determinate rate for the Xpert Xpress CoV-2/Flu/RSV plus test was 0.6% (17/3027).

Table 10. Xpert Xpress CoV-2/Flu/RSV plus Performance Results for NS Specimens

Target	Specimen Collection	Numbers of Specimens	True Positive	False Positive	True Negative	False Negative	PPA (%)	95% two-sided Confidence Interval	NPA (%)	95% two-sided Confidence Interval
SARS-CoV-2	Fresh	2489	442	23 ^a	2017	7 ^b	98.4	96.8 - 99.2	98.9	98.3 - 99.2
	Frozen	26	6	1 ^c	18	1 ^d	85.7	48.7 - 97.4	94.7	75.4 - 99.1
	Overall	2515	448	24	2035	8	98.2	96.6 - 99.1	98.8	98.3 - 99.2
Flu A	Fresh	2553	130	6 ^e	2413	4 ^f	97.0	92.6 - 98.8	99.8	99.5 - 99.9



Target	Specimen Collection	Numbers of Specimens	True Positive	False Positive	True Negative	False Negative	PPA (%)	95% two-sided Confidence Interval	NPA (%)	95% two-sided Confidence Interval
	Frozen	390	66	12 ^g	312	0	100	94.5 - 100.0	96.3	93.6 - 97.9
	Overall	2943	196	18	2725	4	98.0	94.9 - 99.2	99.3	99.0 - 99.6
Flu B	Fresh	2553	0	0	2553	0	NA	NA	100	99.8 - 100.0
	Frozen	390	34	3 ^h	353	0	100	89.8 - 100.0	99.2	97.6 - 99.7
	Overall	2943	34	3	2906	0	100	89.8 - 100.0	99.9	99.7 - 100.0
RSV	Fresh	2553	14	0	2538	1 ⁱ	93.3	70.2 - 98.8	100	99.8 - 100.0
	Frozen	390	55	0	333	2 ^j	96.5	88.1 - 99.0	100	98.9 - 100.0
	Overall	2943	69	0	2871	3	95.8	88.5 - 98.6	100	99.9 - 100.0

- a. Discrepant test results based on a U.S. FDA EUA SARS-CoV-2 molecular test: 6/23 SARS-CoV-2 positive; 14/23 SARS-CoV-2 negative; 2/23 invalid result; 1/23 discrepant testing was inadvertently not performed
- b. Discrepant test results based on a U.S. FDA EUA SARS-CoV-2 molecular test: 2/7 SARS-CoV-2 positive; 5/7 SARS-CoV-2 negative
- c. Discrepant test results based on a U.S. FDA EUA SARS-CoV-2 molecular test: 1/1 SARS-CoV-2 positive
- d. Discrepant test results based on a U.S. FDA EUA SARS-CoV-2 molecular test: 1/1 SARS-CoV-2 negative
- e. Discrepant test results based on a U.S. FDA-cleared molecular respiratory panel: 5/6 Flu A positive; 1/6 Flu A negative
- f. Discrepant test results based on a U.S. FDA-cleared molecular respiratory panel: 2/4 Flu A positive; 2/4 Flu A negative
- g. Discrepant test results based on a U.S. FDA-cleared molecular respiratory panel: 12/12 tests not performed due to specimens being stored for a longer duration than recommended per the package insert
- h. Discrepant test results based on a U.S. FDA-cleared molecular respiratory panel: 3/3 tests not performed due to specimens being stored for a longer duration than recommended per the package insert
- i. Discrepant test results based on a U.S. FDA-cleared molecular respiratory panel: 1/1 RSV positive
- j. Discrepant test results based on a U.S. FDA-cleared molecular respiratory panel: 2/2 tests not performed due to specimens being stored for a longer duration than recommended per the package insert

The number of specimens with positive results for more than one target as detected by Xpert Xpress CoV-2/Flu/RSV plus is presented in [Table 11](#) and [Table 12](#), where bolded values indicate concordant results.

Table 11. Multi-Target Detection by Xpert Xpress CoV-2/Flu/RSV plus for Specimens Collected in 2022

Infection		Comparator Results						Co-Infection Rate (%)
		SARS-CoV-2 only	SARS-CoV-2 and Flu A	Flu A only	RSV only	Negative	Total	
Xpert Xpress CoV-2/Flu/RSV plus	SARS-CoV-2 only	876	1	0	0	57	934	0.3
	SARS-CoV-2 and Flu A	0	2	1	0	0	3	
	Flu A only	0	0	220	0	17	237	
	RSV only	0	0	0	26	0	26	
	Negative	22	0	5	1	3693	3721	
	Total	898	3	226	27	3767	4921	
	Co-Infection Rate (%)	0.3						

As presented in [Table 11](#), a total of 4921 Category I specimens collected in 2022 yielded valid results for SARS-CoV-2, Flu A, and RSV targets for both the Xpert Xpress CoV-2/Flu/RSV plus test and the comparator test. The



co-infection rate for Xpert Xpress CoV-2/Flu/RSV *plus* was 0.3% (3/1200) and the rate of co-infection by the comparator was 0.3% (3/1154).

Table 12. Flu A, Flu B, and RSV Multi-Target Detection by Xpert Xpress CoV-2/Flu/RSV *plus* for Specimens Collected in 2016–2017 and 2022

Infection		Comparator								Co-Infection Rate (%)
		Flu A only	Flu B Only	RSV Only	Flu A and Flu B	Flu A and RSV	Flu B and RSV	Negative	Total	
Xpert Xpress CoV-2/Flu/RSV <i>plus</i>	Flu A only	381	0	0	1	1	0	36	419	1.7
	Flu B Only	0	85	0	0	0	0	2	87	
	RSV Only	0	0	135	0	0	0	0	135	
	Flu A and Flu B	0	4	0	1	0	0	1	6	
	Flu A and RSV	0	0	1	0	3	0	0	4	
	Flu B and RSV	0	0	0	0	0	1	0	1	
	Negative	6	1	3	0	0	0	5292	5302	
	Total	387	90	139	2	4	1	5331	5954	
	Co-Infection Rate (%)	1.1								

As presented in Table 12, of the 5954 Category I and II specimens evaluated for Flu A, Flu B and RSV targets, the co-infection rate for Xpert Xpress CoV-2/Flu/RSV *plus* was 1.7% (11/652) and the rate of co-infection by the comparator was 1.1% (7/623).

Analytical Performance

Analytical Sensitivity / Limit of Detection (LoD)

Clinical Nasopharyngeal Swab (NPS) Matrix

The analytical sensitivity of the Xpert Xpress CoV-2/Flu/RSV *plus* test was first estimated by using 2 reagent lots and testing limiting dilutions of viruses (NATrol SARS-CoV-2, 1st World Health Organization (WHO) International Standard for SARS-CoV-2, Flu A H1, Flu A H3, Flu B Victoria lineage, Flu B Yamagata lineage, RSV A and RSV B) in pooled negative clinical NPS-UTM/VTM matrix, following the guidance in Clinical and Laboratory Standards Institute (CLSI) document EP17-A2. The LoD is defined as the lowest concentration for each strain at which 95% (19/20) of replicates yield a positive result. The estimated LoD values as determined by Probit regression analysis were verified using 2 lots of Xpert Xpress CoV-2/Flu/RSV *plus* reagents, by testing 20 replicates per virus/lot combination. The highest (least sensitive) LoD value for the two lots was reported as the final, verified LoD. The verified LoD values for the viruses tested are summarized in Table 13.



Table 13. Xpert Xpress CoV-2/Flu/RSV plus Limit of Detection in Clinical NPS-UTM/VTM Matrix

Virus/Strain	LoD Concentration
USA-WA1/2020 (NATtrol)	138 copies/mL
1 st WHO International Standard	94 IU/mL
Flu A/Idaho/07/2018	0.007 TCID ₅₀ /mL
Flu A/California/07/2009	0.0022 TCID ₅₀ /mL
Flu A/Hong Kong/45/2019	0.44 FFU/mL
Flu A/Victoria/361/2011	0.05 TCID ₅₀ /mL
Flu B/Washington/2/2019	12.9 CEID ₅₀ /mL
Flu B/Wisconsin/10/2016	2.4 TCID ₅₀ /mL
RSV A/2/Australia/61	0.33 TCID ₅₀ /mL
RSV A/Long/MD/56	0.17 TCID ₅₀ /mL
RSV B/9320/MA/77	0.37 TCID ₅₀ /mL
RSV B/Wash/18537/62	0.2 TCID ₅₀ /mL

Clinical Anterior Nasal Swab (NS) Matrix

The analytical sensitivity of the Xpert Xpress CoV-2/Flu/RSV *plus* test in clinical anterior nasal swab (NS) matrix was first estimated by using 2 lots and testing limiting dilutions of viruses (NATtrol SARS-CoV-2, 1st World Health Organization (WHO) International Standard for SARS-CoV-2, Flu A H1, Flu A H3, Flu B Victoria lineage, Flu B Yamagata lineage, RSV A and RSV B) in pooled negative clinical NS UTM/VTM matrix, following the guidance in Clinical and Laboratory Standards Institute (CLSI) document EP17-A2. The estimated LoD values as determined by Probit regression analysis were verified using 2 lots of Xpert Xpress CoV-2/Flu/RSV *plus* reagents, by testing 20 replicates per virus/lot combination. The highest (least sensitive) LoD value for the two lots was reported as the final, verified LoD. The verified LoD values for the viruses tested are summarized in [Table 14](#).

Table 14. Xpert Xpress CoV-2/Flu/RSV plus Limit of Detection in Clinical NS-UTM/VTM Matrix

Virus/Strain	LoD Concentration
USA-WA1/2020 (NATtrol)	64 copies/mL
1 st WHO International Standard	143 IU/mL
Flu A/Idaho/07/2018	0.012 TCID ₅₀ /mL
Flu A/California/07/2009	0.0028 TCID ₅₀ /mL
Flu A/Hong Kong/45/2019	0.49 FFU/mL
Flu A/Victoria/361/2011	0.065 TCID ₅₀ /mL
Flu B/Washington/2/2019	26.3 CEID ₅₀ /mL
Flu B/Wisconsin/10/2016	2.41 TCID ₅₀ /mL
RSV A/2/Australia/61	0.28 TCID ₅₀ /mL
RSV A/Long/MD/56	0.22 TCID ₅₀ /mL



Virus/Strain	LoD Concentration
RSV B/9320/MA/77	0.27 TCID ₅₀ /mL
RSV B/Wash/18537/62	0.4 TCID ₅₀ /mL

Analytical Reactivity (Inclusivity)

SARS-CoV-2 *in silico* Analyses

The inclusivity of Xpert Xpress CoV-2/Flu/RSV *plus* was evaluated using *in silico* analysis of the assay amplicons in relation to SARS-CoV-2 sequences available in the GISAID gene database as of June 15, 2022. The sequences were separated into the lineages of interest based on the Pango Lineage assigned to each genome by GISAID, and those with ambiguous nucleotides were removed. Thus, the following inclusivity analyses focus on the combined, non-ambiguous sequences from the variants of interest and variants of concern as of June 15, 2022. These constituted 10,310,839 sequences for the E target, 10,428,014 sequences for the N2 target, and 10,178,602 sequences for the RdRP target. [Table 15](#) summarizes the effective predicted inclusivity for E, N2 and RdRP amplicons for the variants of interests and concern.

Table 15. Predicted Inclusivity for E, N2 and RdRP Amplicons for SARS-CoV-2 Variants of Interests and Concern

Amplicon	Exact Match	1 Mismatch ^a	2 or More Mismatches	% Total <2 Mismatches
CEP-COV-E-PLUS	10,262,080 of 10,310,839 (99.5%)	47,959 (0.5%)	800 (0.01%)	100%
CEP-COV-N2	10,228,739 of 10,428,014 (98.1%)	194,319 (1.9%)	4,956 (0.05%)	99.9%
CEP-COV-RDRP	10,092,873 of 10,178,602 (99.2%)	84,595 (0.8%)	1,134 (0.01%)	100%

a. Single-nucleotide mismatches are predicted to not impact the performance of the test.

Based on the built-in redundancy of the Xpert Xpress CoV-2/Flu/RSV *plus* test's SARS-CoV-2 amplification system (i.e., 3 independent targets, only 1 of 3 must be detected to assign a positive result), it is not anticipated that any of the evaluated SARS-CoV-2 sequences would be missed by the Xpert Xpress CoV-2/Flu/RSV *plus* test

SARS-CoV-2, Flu A, Flu B, and RSV Inclusivity Wet-Testing

In addition to the *in silico* analysis of the SARS-CoV-2 primers and probes for inclusivity, the inclusivity of the Xpert Xpress CoV-2/Flu/RSV *plus* test was evaluated by bench testing against multiple strains of SARS-CoV-2, influenza A H1N1 (seasonal pre-2009), influenza A H1N1 (pandemic 2009), influenza A H3N2 (seasonal), avian influenza A (H5N1, H5N2, H6N2, H7N2, H7N3, H2N2, H7N9, and H9N2), influenza B (representing strains from both Victoria and Yamagata lineages), and respiratory syncytial virus subgroups A and B (RSV A and RSV B) at concentrations of ~3x LoD in simulated matrix. A total of 102 respiratory viral strains comprised of 18 SARS-CoV-2 strains, 69 influenza viruses (48 influenza A and 21 influenza B) and 15 RSV strains were evaluated for analytical reactivity (inclusivity) with the Xpert Xpress CoV-2/Flu/RSV *plus* test. Three replicates were tested for each strain. All SARS-CoV-2, Flu and RSV strains tested positive in all 3 replicates. Results are shown in [Table 16](#)



Table 16. Analytical Reactivity (Inclusivity) of the Xpert Xpress CoV-2/Flu/RSV plus Test

Virus	Strain	Target Conc.	Result			
			SARS-CoV-2	Flu A	Flu B	RSV
SARS-CoV-2	NATtrol SARS-CoV-2 USA-WA1/2020	412 copies/mL	POS	NEG	NEG	NEG
	SARS-CoV-2/HongKong/VM20001061/2020	0.03 TCID ₅₀ /mL	POS ^a	NEG	NEG	NEG
	SARS-CoV-2/Italy-INMI1	1 TCID ₅₀ /mL	POS	NEG	NEG	NEG
	SARS-CoV-2/Africa/KRISPK005325/2020 (Beta)	0.025 TCID ₅₀ /mL	POS	NEG	NEG	NEG
	SARS-CoV-2/England/204820464/2020	0.05 TCID ₅₀ /mL	POS	NEG	NEG	NEG
	SARS-CoV-2 (NY-Wadsworth-21033899-01/2021) P1_2021 (Gamma)	0.01 TCID ₅₀ /mL	POS	NEG	NEG	NEG
	SARS-CoV-2 (NY-Wadsworth-21006055-01/2021) P2_2021 (Zeta)	0.03 TCID ₅₀ /mL	POS	NEG	NEG	NEG
	SARS-CoV-2 (NY-Wadsworth-21025952-01/2021) B.1.526_2021 (Iota)	0.1 TCID ₅₀ /mL	POS	NEG	NEG	NEG
	SARS-CoV-2 (NY-Wadsworth-103677-01/2020) B.1_2020	0.003 TCID ₅₀ /mL	POS	NEG	NEG	NEG
	SARS-CoV-2 (NY-Wadsworth-33126-01/2020) B.1.595_2020	0.0015 TCID ₅₀ /mL	POS	NEG	NEG	NEG
	SARS-CoV-2 (USA/CA-Stanford-15_S02/2021) B.1.617.1 (Kappa)	1.7 TCID ₅₀ /mL	POS	NEG	NEG	NEG
	SARS-CoV-2 (USA/PHC658/2021) B.1.617.2 (Delta)	0.01 TCID ₅₀ /mL	POS	NEG	NEG	NEG
	SARS-CoV-2 (USA/MDHP01542/2021) B.1.351 (Beta)	100 (genome equivalents/mL)	POS	NEG	NEG	NEG
	SARS-CoV-2 (USA/GA-EHC-2811C/20221) B.1.1.529 (Omicron)	100 (genome equivalents/mL)	POS	NEG	NEG	NEG
	SARS-CoV-2 RNA, USA/WA2/2020 (C09) ^b	100 copies/mL	POS	NEG	NEG	NEG
	SARS-CoV-2 RNA, England/205041766/2020 (C14) (alpha) ^b	100 copies/mL	POS	NEG	NEG	NEG
	SARS-CoV-2 RNA, England/MILK-9E05B3/2020 (C15) (alpha) ^b	200 copies/mL	POS	NEG	NEG	NEG
	SARS-CoV-2 RNA /Japan (Brazil)/IC-0564/2021 (C17) (gamma) ^b	100 copies/mL	POS	NEG	NEG	NEG
Flu A H1N1 (pre-2009)	A/swine/Iowa/15/30	10 TCID ₅₀ /mL	NEG	POS	NEG	NEG
	A/WS/33	0.6 CEID ₅₀ /mL	NEG	POS	NEG	NEG
	A/PR/8/34	1.25 CEID ₅₀ /mL	NEG	POS	NEG	NEG
	A/Mal/302/54	0.156 CEID ₅₀ /mL	NEG	POS	NEG	NEG
	A/Denver/1/57	1.5 CEID ₅₀ /mL	NEG	POS	NEG	NEG
	A/New Jersey/8/76	5 CEID ₅₀ /mL	NEG	POS	NEG	NEG
	A/New Caledonia/20/1999	0.10 TCID ₅₀ /mL	NEG	POS	NEG	NEG
	A/New York/55/2004	9 TCID ₅₀ /mL	NEG	POS	NEG	NEG
	A/Solomon Island/3/2006	0.0159 TCID ₅₀ /mL	NEG	POS	NEG	NEG



Virus	Strain	Target Conc.	Result			
			SARS-CoV-2	Flu A	Flu B	RSV
	A/Taiwan/42/06	0.002 TCID ₅₀ /mL	NEG	POS	NEG	NEG
	A/Brisbane/59/2007	0.008 TCID ₅₀ /mL	NEG	POS	NEG	NEG
	A/Swine/NY/02/2009	3.2 TCID ₅₀ /mL	NEG	POS	NEG	NEG
Flu A H1N1 (pdm 2009)	A/Colorado/14/2012	0.04 TCID ₅₀ /mL	NEG	POS	NEG	NEG
	A/Michigan/45/2015	15 CEID ₅₀ /mL	NEG	POS	NEG	NEG
	A/Iowa/53/2015	6 CEID ₅₀ /mL	NEG	POS	NEG	NEG
	A/Michigan/272/2017	0.07 TCID ₅₀ /mL	NEG	POS	NEG	NEG
	A/Idaho/07/2018	0.0159TCID ₅₀ /mL	NEG	POS	NEG	NEG
	A/Wisconsin/505/2018	0.08 TCID ₅₀ /mL	NEG	POS	NEG	NEG
	A/Hawaii/66/2019	100 CEID ₅₀ /mL	NEG	POS	NEG	NEG
	A/Indiana/02/2020	NA ^e	NEG	POS	NEG	NEG
Flu A H3N2	A/Aichi/2/68	2 CEID ₅₀ /mL	NEG	POS	NEG	NEG
	A/Hong Kong/8/68	0.25 CEID ₅₀ /mL	NEG	POS	NEG	NEG
	A/Port Chalmers/1/73	8 CEID ₅₀ /mL	NEG	POS	NEG	NEG
	A/Hawaii/15/2001	33 CEID ₅₀ /mL	NEG	POS	NEG	NEG
	A/Wisconsin/67/05c	0.22 TCID ₅₀ /mL	NEG	POS	NEG	NEG
	A/Brisbane/10/2007	0.003 TCID ₅₀ /mL	NEG	POS	NEG	NEG
	A/Minnesota/11/2010	2.4 CEID ₅₀ /mL	NEG	POS	NEG	NEG
	A/Indiana/08/2011	0.02 TCID ₅₀ /mL	NEG	POS	NEG	NEG
	A/Texas/50/2012	0.008 TCID ₅₀ /mL	NEG	POS	NEG	NEG
	A/Alaska/232/2015	2 CEID ₅₀ /mL	NEG	POS	NEG	NEG
	A/Singapore/INFIMH-16-0019/2016	2.5 CEID ₅₀ /mL	NEG	POS	NEG	NEG
	A/Texas/71/2017	1 FFU/mL	NEG	POS	NEG	NEG
	A/Kansas/14/2017	0.15 FFU/mL	NEG	POS	NEG	NEG
	A/Wisconsin/04/2018 ^d	0.15 FFU/mL	NEG	POS	NEG	NEG
	A/Arizona/45/2018	2 FFU/mL	NEG	POS	NEG	NEG
A/Hong Kong/45/2019	0.8 FFU/mL	NEG	POS	NEG	NEG	
Avian Flu A ^e	A/Mallard/NY/6750/78 (H2N2)	< 1 pg/uL	NEG	POS	NEG	NEG
	A/duck/Hunan/795/2002 (H5N1)	< 1 pg/uL	NEG	POS	NEG	NEG
	A/Vietnam/1194/2004 (H5N1)	< 1 pg/uL	NEG	POS	NEG	NEG
	A/Anhui/01/2005 (H5N1)	< 1 pg/uL	NEG	POS	NEG	NEG
	A/Japanese white eye/Hong Kong/1038/2006 (H5N1)	< 1 pg/uL	NEG	POS	NEG	NEG
	A/mallard/WI/34/75 (H5N2)	< 1 pg/uL	NEG	POS	NEG	NEG
	A/turkey/Massachusetts/3740/1965 (H6N2)	0.1 fg/uL	NEG	POS	NEG	NEG



Virus	Strain	Target Conc.	Result			
			SARS-CoV-2	Flu A	Flu B	RSV
	A/duck/LTC-10-82743 (H7N2)	5 fg/uL	NEG	POS	NEG	NEG
	A/chicken/New Jersey/15086/3 (H7N3)	4 fg/uL	NEG	POS	NEG	NEG
	A/Anhui/1/2013 (H7N9)	0.612 ng/uL	NEG	POS	NEG	NEG
	A/Shanghai/1/2013 (H7N9)	NA ^f	NEG	POS	NEG	NEG
	A/chicken/New Jersey/12220/1997 (H9N2)	0.05 pg/uL	NEG	POS	NEG	NEG
Flu B	B/Lee/40	0.08 PFU/mL	NEG	NEG	POS	NEG
	B/Allen/45	0.25 CEID ₅₀ /mL	NEG	NEG	POS	NEG
	B/GL/1739/54	0.50 CEID ₅₀ /mL	NEG	NEG	POS	NEG
	B/Maryland/1/59	0.2 CEID ₅₀ /mL	NEG	NEG	POS	NEG
	B/Taiwan/2/62	0.7 CEID ₅₀ /mL	NEG	NEG	POS	NEG
	B/Hong Kong/5/72	1 CEID ₅₀ /mL	NEG	NEG	POS	NEG
Flu B (Victoria Lineage)	B/Panama/45/90	0.125 TCID ₅₀ /mL	NEG	NEG	POS	NEG
	B/Malaysia/2506/04	0.001 TCID ₅₀ /mL	NEG	NEG	POS	NEG
	B/Florida/02/06	0.004 TCID ₅₀ /mL	NEG	NEG	POS	NEG
	B/Brisbane/60/2008	0.005 TCID ₅₀ /mL	NEG	NEG	POS	NEG
	B/Maryland/15/2016	0.06 TCID ₅₀ /mL	NEG	NEG	POS	NEG
	B/Colorado/6/2017	0.01 TCID ₅₀ /mL	NEG	NEG	POS	NEG
	B/Hawaii/01/2018	1 TCID ₅₀ /mL	NEG	NEG	POS	NEG
	B/Missouri/12/2018 (NA D197E)	1.2 TCID ₅₀ /mL	NEG	NEG	POS	NEG
B/Washington/02/2019	60 TCID ₅₀ /mL	NEG	NEG	POS	NEG	
Flu B (Yamagata Lineage)	B/Florida/07/2004	0.03 TCID ₅₀ /mL	NEG	NEG	POS	NEG
	B/Florida/04/06	0.03 TCID ₅₀ /mL	NEG	NEG	POS	NEG
	B/Wisconsin/01/2010	0.025 CEID ₅₀ /mL	NEG	NEG	POS	NEG
	B/Wisconsin/10/2016	2 TCID ₅₀ /mL	NEG	NEG	POS	NEG
	B/Indiana/17/2017	0.5 TCID ₅₀ /mL	NEG	NEG	POS	NEG
	B/Oklahoma/10/2018	1 TCID ₅₀ /mL	NEG	NEG	POS	NEG
RSV A	RSV-A/NY	0.386 TCID ₅₀ /mL	NEG	NEG	NEG	POS
	RSV-A/WI-629.8.2/2007	0.50 TCID ₅₀ /mL	NEG	NEG	NEG	POS
	RSV-A/WI/629-11-1_2008	0.50 TCID ₅₀ /mL	NEG	NEG	NEG	POS
	RSV-A, Strain: 4/2015 Isolate #1	0.03 TCID ₅₀ /mL	NEG	NEG	NEG	POS
	RSV-A (2014, Isolate 342)	0.38 IU/mL	NEG	NEG	NEG	POS
	RSV-A (A2 cpts-248 mutant)	1600 copies/mL	NEG	NEG	NEG	POS
	RSV-A (2000/3-4)	0.0015 TCID ₅₀ /mL	NEG	NEG	NEG	POS
	RSV-A (2001/3-12)	0.28 TCID ₅₀ /mL	NEG	NEG	NEG	POS
	RSV-A (1997/12-35)	0.5 TCID ₅₀ /mL	NEG	NEG	NEG	POS



Virus	Strain	Target Conc.	Result			
			SARS-CoV-2	Flu A	Flu B	RSV
	RSV-A (<i>Homo sapiens</i> /ARG/177/2006)	0.089 TCID ₅₀ /mL	NEG	NEG	NEG	POS
	RSV-A (1998/3-2)	0.0089TCID ₅₀ /mL	NEG	NEG	NEG	POS
RSV B	RSV-B/WV14617/85	0.04 TCID ₅₀ /mL	NEG	NEG	NEG	POS
	RSV-B-CH93(18)-18-01	0.004 TCID ₅₀ /mL	NEG	NEG	NEG	POS
	RSV-B (12/2014, Isolate #1)	0.008 TCID ₅₀ /mL	NEG	NEG	NEG	POS
	RSV-B (cp23 Clone 1A2)	4200 copies/mL	NEG	NEG	NEG	POS

- One of three replicates was Invalid. The run was successfully repeated to obtain three valid replicates.
- In vitro* transcripts from Twist Biosciences.
- Influenza A/Indiana/02/2020 virus was without titer and the stock was diluted 48,000-fold in simulated matrix for testing.
- One of three replicates yielded an **ERROR** result. The run was successfully repeated to obtain three valid replicates.
- Purified viral RNA in TE and diluted in simulated matrix was tested due to biosafety regulations.
- Inactivated avian influenza A (H7N9) viral RNA without viral titer was diluted 100,000-fold in simulated matrix for testing due to biosafety regulations.

Analytical Specificity (Exclusivity)

In silico Analyses

An *in silico* analysis for possible cross-reactions with all the organisms listed in **Table 17** was conducted by mapping the SARS-CoV-2 oligonucleotides and amplicons in the Xpert Xpress CoV-2/Flu/RSV *plus* test individually to the sequences downloaded from the GISAID database. E gene primers and probes are not specific for SARS-CoV-2 and will detect Human and Bat SARS-coronavirus.

In silico exclusivity analysis using Flu A, Flu B and RSV B primer and probe oligonucleotides against the GenBank database (which encompasses essentially all species) did not identify matches, with at least 80% similarity to each oligonucleotide, for any non-target organism expected to be found in a human respiratory tract sample. The RSV A primer and probe oligonucleotides exhibited $\geq 80\%$ homology with two Pangolin RSV A isolates. Therefore, the RSV A primers and probe may cross-react with Pangolin RSV A if the strain is circulating in a human population and present in a sample tested with the Xpert Xpress CoV-2/Flu/RSV *plus* test. While there was some homology $\geq 80\%$ to human genomic DNA, the matches were to different chromosomal regions, and there were no cases where a forward and reverse primer for a specific target matched to the same human genomic DNA fragment.

In silico exclusivity analysis using the five Flu amplicons (Flu A MP, Flu A PB2, Flu A PA, Flu B MP and Flu B NS) against the GenBank database produced no significant matches to non-influenza-related sequences. Similarly, no matches to RSV isolates from other species or to genomic sequences from non-RSV species were observed with the RSV B amplicon. While no matches of the RSV A amplicon to genomic sequences from non-RSV species of $\geq 80\%$ homology were observed, the RSV A amplicon shared a 95% identity with two Pangolin RSV A isolates.

No cross reactivity with non-SARS-CoV-2, non-influenza and non-RSV viruses listed in **Table 17** is expected based on the *in silico* analysis.

**Table 17. Microorganisms Analyzed in the *in silico* Analysis for the SARS-CoV-2 Target**

Microorganisms from the Same Genetic Family	High Priority Organisms
Human coronavirus 229E	Viruses
Human coronavirus OC43	Adenovirus (e.g., C1 Ad. 71)
Human coronavirus HKU1	Cytomegalovirus
Human coronavirus NL63	Enterovirus (e.g., EV68)
SARS-coronavirus	Epstein-Barr virus
MERS-coronavirus	Human Metapneumovirus (hMPV)
Bat coronavirus	Influenza A & B
	Measles
	Mumps
	Parainfluenza virus 1-4
	Parechovirus
	Respiratory syncytial virus
	Rhinovirus
	Bacteria
	<i>Bacillus anthracis</i>
	<i>Bordetella pertussis</i>
	<i>Bordetella parapertussis</i>
	<i>Candida albicans</i>
	<i>Chlamydia pneumoniae</i>
	<i>Chlamydia psittaci</i>
	<i>Corynebacterium diphtheriae</i>
	<i>Coxiella burnetii</i> (Q-Fever)
	<i>Escherichia coli</i>
	<i>Fusobacterium necrophorum</i>
	<i>Haemophilus influenzae</i>
	<i>Lactobacillus</i> sp.
	<i>Legionella non-pneumophila</i>
	<i>Legionella pneumophila</i>
	<i>Leptospira</i>
	<i>Moraxella catarrhalis</i>
	<i>Mycobacterium tuberculosis</i>
	<i>Mycoplasma genitalium</i>
	<i>Mycoplasma pneumoniae</i>
	<i>Neisseria elongata</i>
	<i>Neisseria meningitidis</i>
	<i>Pneumocystis jirovecii</i> (PJP)
	<i>Pseudomonas aeruginosa</i>
	<i>Staphylococcus aureus</i>



Microorganisms from the Same Genetic Family	High Priority Organisms
	<i>Staphylococcus epidermidis</i>
	<i>Staphylococcus salivarius</i>
	<i>Streptococcus pneumoniae</i>
	<i>Streptococcus pyogenes</i>
	Fungi
	<i>Aspergillus</i> sp

Wet-Testing

In addition to the *in silico* analysis of the SARS-CoV-2, influenza A, influenza B, and RSV oligonucleotides and amplicons for cross-reactivity, the analytical specificity of the Xpert Xpress CoV-2/Flu/RSV *plus* test was evaluated by bench testing a panel of 48 microorganisms, comprising 4 human coronaviruses, 1 MERS coronavirus and 43 common respiratory pathogens or those potentially encountered in the nasopharynx. The panel was tested in different pools of microorganisms; if a pool produced a positive result, then each member of the pool would have been tested individually. Three replicates of each pool were tested. A sample was considered negative if all three replicates were negative. The bacterial and yeast strains were tested at concentrations of $\geq 1 \times 10^6$ CFU/mL with the exception of *Chlamydia pneumoniae* which was tested at 1.2×10^6 IFU/mL and *Lactobacillus reuteri* which was tested at 5×10^7 copies/mL of genomic DNA. Viruses were tested at concentrations of $\geq 1 \times 10^5$ TCID₅₀/mL. The analytical specificity was 100%. Results are shown in Table 18.

Table 18. Respiratory Microorganisms and Human Coronavirus Tested, Concentrations and Xpert Xpress CoV-2/Flu/RSV *plus* Test Results

Count	Strain	Tested Concentration	SARS-CoV-2	Flu A	Flu B	RSV
0	Negative Control	Not Applicable	NEG	NEG	NEG	NEG
00	Positive Control (NATFRC-6C)	Not Applicable	POS	POS	POS	POS
1	Human coronavirus NL63	1.17e5 TCID ₅₀ /mL	NEG	NEG	NEG	NEG
2	MERS-coronavirus	1.17e5 TCID ₅₀ /mL	NEG	NEG	NEG	NEG
3	Human coronavirus 229E	1.21e5 TCID ₅₀ /mL	NEG	NEG	NEG	NEG
4	Human coronavirus OC43	1.02e5 TCID ₅₀ /mL	NEG	NEG	NEG	NEG
5	Human coronavirus HKU1 ^a	1.23e6 copies/mL	NEG	NEG	NEG	NEG
6	Adenovirus Type 1	4.07e5 TCID ₅₀ /mL	NEG	NEG	NEG	NEG
7	Adenovirus Type 7	1.15e5 TCID ₅₀ /mL	NEG	NEG	NEG	NEG
8	Cytomegalovirus	1.0e5 TCID ₅₀ /mL	NEG	NEG	NEG	NEG
9	Echovirus	1.14e5 TCID ₅₀ /mL	NEG	NEG	NEG	NEG
10	Enterovirus	2.80e5 TCID ₅₀ /mL	NEG	NEG	NEG	NEG
11	Epstein Barr Virus	5.60e6 TCID ₅₀ /mL	NEG	NEG	NEG	NEG
12	HSV	1.97e5 TCID ₅₀ /mL	NEG	NEG	NEG	NEG
13	Human metapneumovirus	4.07e5 TCID ₅₀ /mL	NEG	NEG	NEG	NEG
14	Human parainfluenza Type 1	1.0e5 TCID ₅₀ /mL	NEG	NEG	NEG	NEG
15	Human parainfluenza Type 2	1.2e5 TCID ₅₀ /mL	NEG	NEG	NEG	NEG
16	Human parainfluenza Type 3	1.2e5 TCID ₅₀ /mL	NEG	NEG	NEG	NEG
17	Human parainfluenza Type 4	1.19e6 TCID ₅₀ /mL	NEG	NEG	NEG	NEG



Count	Strain	Tested Concentration	SARS-CoV-2	Flu A	Flu B	RSV
18	Measles	1.2e5 TCID ₅₀ /mL	NEG	NEG	NEG	NEG
19	Mumps virus	1.2e5 TCID ₅₀ /mL	NEG	NEG	NEG	NEG
20	Rhinovirus Type 1A	1.0e5 TCID ₅₀ /mL	NEG	NEG	NEG	NEG
21	<i>Acinetobacter baumannii</i>	1.30e7 CFU/mL	NEG	NEG	NEG	NEG
22	<i>Bordetella pertussis</i>	6.40e7 CFU/mL	NEG	NEG	NEG	NEG
23	<i>Burkholderia cepacia</i>	1.90e8 CFU/mL	NEG	NEG	NEG	NEG
24	<i>Candida albicans</i>	6.30e6 CFU/mL	NEG	NEG	NEG	NEG
25	<i>Candida parapsilosis</i>	1.45e6 CFU/mL	NEG	NEG	NEG	NEG
26	<i>Citrobacter freundii</i>	1.73e8 CFU/mL	NEG	NEG	NEG	NEG
27	<i>Corynebacterium sp.</i>	1.27e7 CFU/mL	NEG	NEG	NEG	NEG
28	<i>Enterococcus faecalis</i>	5.87e7 CFU/mL	NEG	NEG	NEG	NEG
29	<i>Escherichia coli</i>	1.55e8 CFU/mL	NEG	NEG	NEG	NEG
30	<i>Hemophilus influenzae</i>	6.62e6 CFU/mL	NEG	NEG	NEG	NEG
31	<i>Lactobacillus reuteri</i> ^b	5.0e7 copies/mL	NEG	NEG	NEG	NEG
32	<i>Legionella pneumophila</i>	1.42e8 CFU/mL	NEG	NEG	NEG	NEG
33	<i>Moraxella catarrhalis</i>	2.46e6 CFU/mL	NEG	NEG	NEG	NEG
34	<i>Mycoplasma pneumoniae</i>	2.7e6 CFU/mL	NEG	NEG	NEG	NEG
35	<i>Neisseria meningitidis</i>	4.2e6 CFU/mL	NEG	NEG	NEG	NEG
36	<i>Neisseria mucosa</i>	1.0e8 CFU/mL	NEG	NEG	NEG	NEG
37	<i>Propionibacterium acnes</i>	8.25e7 CFU/mL	NEG	NEG	NEG	NEG
38	<i>Pseudomonas aeruginosa</i>	1.05e7 CFU/mL	NEG	NEG	NEG	NEG
39	<i>Staphylococcus haemolyticus</i>	2.66e6 CFU/mL	NEG	NEG	NEG	NEG
40	<i>Staphylococcus aureus</i>	5.87e7 CFU/mL	NEG	NEG	NEG	NEG
41	<i>Staphylococcus epidermidis</i>	2.47e7 CFU/mL	NEG	NEG	NEG	NEG
42	<i>Streptococcus agalactiae</i>	1.75e7 CFU/mL	NEG	NEG	NEG	NEG
43	<i>Streptococcus pneumoniae</i>	2.26e7 CFU/mL	NEG	NEG	NEG	NEG
44	<i>Streptococcus pyogenes</i>	9.0e6 CFU/mL	NEG	NEG	NEG	NEG
45	<i>Streptococcus salivarius</i>	4.19e6 CFU/mL	NEG	NEG	NEG	NEG
46	<i>Streptococcus sanguinis</i>	8.67e6 CFU/mL	NEG	NEG	NEG	NEG
47	<i>Chlamydia pneumoniae</i>	1.20e6 CFU/mL	NEG	NEG	NEG	NEG
48	<i>Mycobacterium tuberculosis (avirulent)</i>	1.20e6 CFU/mL	NEG	NEG	NEG	NEG

a. Live virus was not available. Synthetic RNA was used.

b. Live organism was not available. Genomic DNA was used.

Microbial Interference

Microbial interference of the Xpert Xpress CoV-2/Flu/RSV *plus* test caused by the presence of bacterial or viral strains that might be encountered in human upper respiratory tract specimens, was evaluated by testing a panel of 10 potentially interfering microorganisms, consisting of 7 viral strains and 3 bacterial strains. Contrived samples consisted of SARS-CoV-2, Flu A, Flu B, RSV A, or RSV B viruses seeded at 3x the Limit of Detection (LoD) into simulated nasopharyngeal swab (NPS)/nasal swab (NS) matrix in the presence of



Adenovirus Type 1C, Human Coronavirus OC43, Rhinovirus Type 1A, Human metapneumovirus, Human parainfluenza Types 1, 2, and 3 (each seeded at 1×10^5 TCID₅₀/mL), *Hemophilus influenzae* (seeded at 1×10^6 CFU/mL), *Staphylococcus aureus* or *Staphylococcus epidermidis* (each seeded at 1×10^7 CFU/mL).

Eight (8) replicates of the positive samples were tested for each target virus (SARS-CoV-2, Flu A, Flu B, RSV A, or RSV B) and each potential microbial interference strain combination. For each target, all 8 of 8 replicates of the positive samples were correctly identified using the Xpert Xpress CoV-2/Flu/RSV *plus* test. No microbial interference by the viral or bacterial strains was reported.

Competitive Interference

Competitive interference of the Xpert Xpress CoV-2/Flu/RSV *plus* caused by co-infections were evaluated by testing contrived samples of individual SARS-CoV-2, Flu A, Flu B or RSV strains at 3x LoD in the presence of different target strains at a higher concentration in a simulated background matrix. The concentration at 3x LoD was 414 copies/mL for SARS-CoV-2 (inactivated USA-WA1/2020); 0.021 TCID₅₀/mL for Flu A/Idaho/07/2018, 38.7 CEID₅₀/mL for Flu B/Washington/2/2019; 0.99 TCID₅₀/mL for RSV A/2/Australia/61, and 1.11 TCID₅₀/mL for RSV B/9320/MA/77. The competitive strains were evaluated at $\geq 10^5$ RNA (copies/mL) as determined by droplet digital PCR (ddPCR).

Replicates of 3 were tested for each target strain and each competitive strain combination. The virus at high concentration shows no competitive inhibitory effects if 3 of 3 replicates for the target strain report positive results. If the results reported less than 3 of 3 positive replicates, the concentration of the competing virus was reduced by 10-fold increments until no interference was observed. The results for competitive interference study are presented in [Table 19](#) through [Table 23](#) for high concentration of Flu A, Flu B, RSV A, RSV B and SARS-CoV-2, respectively.

Table 19. Summary of Competitive Interference Study with Flu A at High Concentration

Test Viruses at 3X LoD	Interferent Virus	Correct Calls (n/3)			
		at 1.7e8 RNA copies/mL	at 1.7e7 RNA copies/mL	at 1.7e6 RNA copies/mL	at 1.7e5 RNA copies/mL
Flu B	Flu A	0/3	0/3	2/3	3/3
RSV A		0/3	0/3	3/3	Not tested
RSV B		3/3	Not tested	Not tested	Not tested
SARS-CoV-2		3/3	Not tested	Not tested	Not tested

Table 20. Summary of Competitive Interference Study with Flu B at High Concentration

Test Viruses at 3X LoD	Interferent Virus	Correct Calls (n/3) at 1.4e5 RNA copies/mL
Flu A	Flu B	3/3
RSV A		3/3
RSV B		3/3
SARS-CoV-2		3/3

**Table 21. Summary of Competitive Interference Study with RSV A at High Concentration**

Test Viruses at 3X LoD	Interferent Virus	Correct Calls (n/3) at 4.6e6 RNA copies/mL
Flu A	RSV A	3/3
Flu B		3/3
SARS-CoV-2		3/3

Table 22. Summary of Competitive Interference Study with RSV B at High Concentration

Test Viruses at 3X LoD	Interferent Virus	Correct Calls (n/3) at 1.9e5 RNA copies/mL
Flu A	RSV B	3/3
Flu B		3/3
SARS-CoV-2		3/3

Table 23. Summary of Competitive Interference Study with SARS-CoV-2 at High Concentration

Test Viruses at 3X LoD	Interferent Virus	Correct Calls (n/3)	
		at 1e6 RNA copies/mL	at 1e5 RNA copies/mL
Flu A	SARS-CoV-2	3/3	Not tested
Flu B		1/3	3/3
RSV A		3/3	Not tested
RSV B		3/3	Not tested

The study showed that Flu A/Idaho/07/2018 at concentrations above 1.7e5 RNA copies/mL inhibited detection of Flu B at 3x LoD, and at concentrations above 1.7e6 RNA copies/mL inhibited detection of RSV A at 3x LoD (Table 19). In addition, SARS-CoV-2 at concentrations above 1e5 RNA copies/mL inhibited detection of Flu B at 3x LoD (Table 23). No other competitive interference was observed for the potential co-infections tested in the study at the concentrations tested.

Potentially Interfering Substances

Substances that are normally found in or may be introduced into clinical NPS or NS matrix that could potentially interfere with accurate detection of SARS-CoV-2, Flu A, Flu B and RSV were evaluated with direct testing on the Xpert Xpress CoV-2/Flu/RSV *plus*.

Potentially interfering substances in the nasal passage and nasopharynx may include, but are not limited to: blood, nasal secretions or mucus, and nasal and throat medications used to relieve congestion, nasal dryness, irritation, or asthma and allergy symptoms, as well as antibiotics and antivirals. Positive and negative samples were prepared in simulated nasopharyngeal swab (NPS)/ nasal swab (NS) matrix. Negative samples (N = 8) were tested in the presence of each substance to determine the effect on the performance of the sample processing control (SPC). Positive samples (N = 8) were tested per substance with viruses spiked at 3x the LoD determined for each strain. Positive samples tested with the Xpert Xpress CoV-2/Flu/RSV *plus* included one SARS-CoV-2, two influenza A H1N1, two influenza A H3N2, two influenza B and two RSV (RSV A and RSV B) strains. The substances, with active ingredients, that were evaluated are listed in Table 24.

**Table 24. Potentially Interfering Substances Tested**

Substance ID	Substance/Class	Substance/Active Ingredient	Concentrations Tested
No substance	Control	Simulated NPS/NS Matrix	100% (v/v)
Albuterol Sulfate	Beta-adrenergic bronchodilator	Albuterol Sulfate (5mg/mL)	0.83 mg/mL (equivalent to 1 dose per day)
Afrin	Nasal Spray	Oxymetazoline, 0.05%	15% (v/v)
BD Universal Transport Medium	Transport Media	N/A	100% (v/v)
Blood	Blood	Blood (Human)	2% (v/v)
Copan Swab M	Transport Media	N/A	100% (v/v)
FluMist Quadrivalent	Vaccine	Live attenuated influenza viruses	6.7e-4% (v/v)
			6.7e-6% (v/v)
			6.7e-7% (v/v)
Fluticasone Propionate Nasal Spray	Nasal corticosteroid	Fluticasone Propionate	5 µg/mL
Human peripheral blood mononuclear cells	Human cells	PBMC	1 x 10 ⁶ cells/mL
			0.5 x 10 ⁶ cells/mL
			0.25 x 10 ⁶ cells/mL
Ibuprofen	Nonsteroidal anti-inflammatory drug	Ibuprofen 200 mg/tablet	5% w/v
Menthol	Throat lozenges, oral anesthetic and analgesic	Benzocaine, Menthol	1.7 mg/mL
Mucin	Mucin	Purified Mucin protein (Bovine or porcine submaxillary gland)	0.1 (w/v)
Mupirocin	Antibiotic, nasal ointment	Mupirocin (20 mg/g = 2%)	10 mg/mL
PHNY	Nasal Drops	Phenylephrine, 1%	15% (v/v)
Remel M4RT	Transport Media	N/A	100% (v/v)
Remel M5	Transport Media	N/A	100% (v/v)
Saline	Saline Nasal Spray	Sodium Chloride (0.65%)	15% (v/v)
Snuff	Tobacco product	Nicotine	1% (w/v)
			0.5% (w/v)
			0.25% (w/v)
			0.1% (w/v)
Tamiflu	Anti-viral drugs	Zanamivir	7.5 mg/mL
Tobramycin	Antibacterial, systemic	Tobramycin	4 µg/mL
Zicam	Nasal Gel	Luffa operculata, Galphimia glauca, Histaminum hydrochloricum Sulfur (0.05%)	15% (w/v)
			7.5% (w/v)
Zinc	Zinc supplement	Zinc Gluconate	0.1 µg/mL

The results from the study (Table 25) show that for most cases, 8 out of 8 replicates reported positive results



for each combination of virus and substance tested and no interference was observed. In the presence of FluMist at 6.7e-4% (v/v), interfering effects were observed when testing SARS-CoV-2, RSV A and RSV B strains. Inhibitory effects were not observed when testing these viruses in the presence of FluMist at 6.7e-6% (v/v) except for RSV A/Long/MD/56. For RSV A/Long/MD/56, the inhibitory effect was not observed when FluMist concentration was further reduced to 6.7e-7% (v/v). In the presence of human PBMC at 1 x 10⁶ cells/mL, interfering effects were observed when testing Flu B/Washington /2/2019. Inhibitory effects were not observed when the PBMC concentration was reduced to 2.5 x 10⁵ cells/mL. In the presence of snuff at 1% (w/v), interfering effects were observed when testing Flu A /California/07/2009 and Flu B/Washington/2/2019. Inhibitory effects were not observed when testing the viruses at a snuff concentration of 0.1% (w/v). In the presence of Zicam at 15% (w/v), interfering effects were observed when testing Flu A, Flu B and RSV A strains. Inhibitory effects were not observed when testing the viruses in the presence of Zicam at 7.5% (w/v).

Table 25. Number of Correct Results for Xpert Xpress CoV-2/Flu/RSV plus Targets Tested in the Presence of Potentially Interfering Substances

Substance	Concentration Tested	Number of Correct Results/Number Tested for Each Virus and the No Virus Control					
		No Virus Control	WA-1 SARS-CoV-2/USA	/California/Flu A 7/2009	/Idaho/Flu A 07/2018	/Hong Kong/Flu A /45/2019	/Victoria/Flu A 361/2011
Control Simulated NPS/NS Matrix (No substance)	100% (v/v)	32/32 ^a	24/24	24/24	16/16	16/16	24/24 ^b
Albuterol Sulfate	0.83 mg/mL	16/16	8/8	8/8	8/8	8/8	8/8
Afrin	15% (v/v)	16/16	8/8	8/8 ^b	8/8	8/8	8/8
BD Universal Transport Medium	100% v/v	16/16	8/8	8/8	8/8	8/8	8/8 ^b
Blood	2% (v/v)	16/16	8/8	8/8	8/8	8/8	8/8
Copan Swab M	100% (v/v)	16/16	8/8	8/8	8/8	8/8	8/8
FluMist	6.7% (v/v)	8/8	N/A	N/A	N/A	N/A	N/A
	6.7e-4% (v/v)	N/A	7/8	N/A	N/A	N/A	N/A
	6.7e-6% (v/v)	N/A	8/8	N/A	N/A	N/A	N/A
	6.7e-7% (v/v)	N/A	N/A	N/A	N/A	N/A	N/A
Fluticasone Propionate Nasal Spray	5 µg/mL	16/16	8/8	8/8	8/8	8/8	8/8
Human peripheral blood mononuclear cells	1e6 cells/mL	8/8	8/8	8/8 ^b	8/8 ^b	8/8	8/8
	0.5e6 cells/mL	N/A	N/A	N/A	N/A	N/A	N/A
	0.25e6 cells/mL	N/A	N/A	N/A	N/A	N/A	N/A
Ibuprofen	5% (w/v)	8/8	8/8	8/8	8/8	8/8	8/8
Menthol	1.7 mg/mL	16/16 ^a	8/8	8/8	8/8	8/8 ^a	8/8
Mucin	0.1% (w/v)	16/16	8/8	8/8	8/8	8/8	8/8
Mupirocin	10 mg/mL	16/16	8/8	8/8	8/8	8/8	8/8
PHNY	15% (v/v)	16/16	8/8	8/8	8/8	8/8	8/8
Remel M4RT	100% (v/v)	16/16 ^a	8/8	8/8	8/8	8/8	8/8
Remel M5	100% (v/v)	16/16	8/8	8/8	8/8	8/8	8/8
Saline	15% (v/v)	16/16	8/8	8/8 ^a	8/8	8/8	8/8



Substance	Concentration Tested	Number of Correct Results/Number Tested for Each Virus and the No Virus Control					
		No Virus Control	WA-1 SARS-CoV-2/USA-	/California/Flu A 7/2009	/Idaho/Flu A 07/2018	/Hong Kong/Flu A /45/2019	/Victoria/Flu A 361/2011
Snuff	1% (w/v)	8/8	8/8	6/8	8/8	8/8 ^b	8/8
	0.5% (w/v)	N/A	N/A	7/8	N/A	N/A	N/A
	0.25 % (w/v)	N/A	N/A	8/8	N/A	N/A	N/A
	0.1 % (w/v)	N/A	N/A	N/A	N/A	N/A	N/A
Tamiflu	7.5 mg/mL	16/16 ^a	8/8	8/8	8/8	8/8	8/8
Tobramycin	4 µg/mL	16/16	8/8	8/8	8/8	8/8	8/8
Zicam	15% (w/v)	16/16	8/8	7/8	8/8	8/8	8/8
	7.5% (w/v)	N/A	N/A	8/8	N/A	N/A	N/A
Zinc	0.1µg/mL	16/16	8/8	8/8	8/8	8/8	8/8

- a. One replicate reported NO RESULT. The run was successfully repeated to obtain the required number of valid replicates.
- b. One replicate reported ERROR. The run was successfully repeated to obtain the required number of valid replicates.

Table 26. Number of Correct Results for Xpert Xpress CoV-2/Flu/RSV plus Targets Tested in the Presence of Potentially Interfering Substances

Substance	Concentration Tested	Number of Correct Results/Number Tested for Each Virus and the No Virus Control					
		Wisconsin/Flu B 10/2016	Washington/Flu B 02/2019	2/ Australia/ RSV A 61	Long/ RSV A MD/56	9320/ RSV B MA/77	WA/ RSV B 18537/62
Control Simulated NPS/NS Matrix (No substance)	100% (v/v)	24/24	32/32	32/32 ^a	32/32	24/24	24/24
Albuterol Sulfate	0.83 mg/mL	8/8	8/8	8/8	8/8	8/8	8/8
Afrin	15% (v/v)	8/8	8/9 ^a	8/8	8/8	8/8	8/8
BD Universal Transport Medium	100% v/v	8/8	8/8	8/8	8/8	8/8	8/8
Blood	2% (v/v)	8/8 ^a	8/8	8/8 ^a	8/8 ^a	8/8	8/8
Copan Swab M	100% (v/v)	8/8	8/8	8/8	8/8	8/8	8/8
FluMist	6.7% (v/v)	N/A	N/A	N/A	N/A	N/A	N/A
	6.7e-4% (v/v)	N/A	N/A	0/8	0/8	2/8	0/8
	6.7e-6% (v/v)	N/A	N/A	8/8	7/8	8/8 ^a	8/8
	6.7e-7% (v/v)	N/A	N/A	N/A	8/8 ^a	N/A	N/A
Fluticasone Propionate Nasal Spray	5 µg/mL	8/8 ^{a, a}	8/8	8/8 ^b	8/8	8/8 ^a	8/8
Human peripheral blood mononuclear cells	1e6 cells/mL	8/8	6/8	8/8 ^a	8/8	8/8 ^a	8/8 ^a
	0.5e6 cells/mL	N/A	7/8	N/A	N/A	N/A	N/A
	0.25e6 cells/mL	N/A	8/8	N/A	N/A	N/A	N/A
Ibuprofen	5% (w/v)	8/8	8/8	8/8	8/8	8/8	8/8



Substance	Concentration Tested	Number of Correct Results/Number Tested for Each Virus and the No Virus Control					
		Wisconsin/ Flu B 10/2016	Washington/ Flu B 02/2019	2/ Australia/ RSV A 61	Long/ RSV A MD/56	9320/ RSV B MA/77	WA/ RSV B 18537/62
Menthol	1.7 mg/mL	8/8 ^a	8/8	8/8	8/8 ^a	8/8	8/8
Mucin	0.1% (w/v)	8/8	8/8	8/8	8/8 ^{a, a}	8/8	8/8
Mupirocin	10 mg/mL	8/8	8/8	8/8	8/8	8/8	8/8
PHNY	15% (v/v)	8/8	8/8	8/8	8/8	8/8	8/8
Remel M4RT	100% (v/v)	8/8	8/8	8/8	8/8	8/8	8/8
Remel M5	100% (v/v)	8/8	8/8	8/8	8/8	8/8	8/8
Saline	15% (v/v)	8/8	8/8	8/8	8/8	8/8	8/8 ^a
Snuff	1% (w/v)	8/8	4/8^a	8/8	8/8	8/8	8/8 ^c
	0.5% (w/v)	N/A	3/8	N/A	N/A	N/A	N/A
	0.25 % (w/v)	N/A	7/8	N/A	N/A	N/A	N/A
	0.1 % (w/v)	N/A	8/8	N/A	N/A	N/A	N/A
Tamiflu	7.5 mg/mL	8/8	8/8	8/8	8/8	8/8	8/8
Tobramycin	4 µg/mL	8/8	8/8	8/8	8/8	8/8	8/8
Zicam	15% (w/v)	8/8 ^a	5/8	7/8	8/8	8/8	8/8
	7.5% (w/v)	N/A	8/8	8/8	N/A	N/A	N/A
Zinc	0.1µg/mL	8/8	8/8	8/8	8/8	8/8	8/8

- a. One of 8 replicates reported a Flu B NEGATIVE result. The Flu B Probe check signals were reduced in this sample suggesting an issue with the EZR bead. The test was repeated and gave a Flu B positive result.
- b. One of 8 replicates reported INVALID. The run was successfully repeated to obtain 8 valid replicates.
- c. Two of 8 replicates reported ERROR. The 2 runs were successfully repeated to obtain 8 valid replicates.

BOLD: False negative or INVALID results indicating interference from the substance

Carry-over Contamination

A study was conducted to assess whether the single-use, self-contained Xpert Xpress CoV-2/Flu/RSV *plus* cartridge prevents specimen and amplicon carryover by testing a negative sample immediately after testing of a very high positive sample in the same GeneXpert module. The negative sample used in this study consisted of simulated NPS/NS matrix and the positive sample consisted of high Flu B and high SARS-CoV-2 virus concentrations (Flu B/Wisconsin/10/2016 at 1.0e6 TCID₅₀/mL and inactivated SARS-CoV-2 USA-WA1/2020 at 1e4 copies/mL) seeded into simulated NPS/NS matrix. The negative sample was tested in a GeneXpert module at the start of the study. Following the initial testing of the negative sample, the high positive sample was processed in the same GeneXpert module immediately followed by another negative sample. This was repeated 20 times in the same module, resulting in 20 positives and 21 negatives for the module. The study was repeated using a second GeneXpert module for a total of 40 positive and 42 negative samples. All 40 positive samples were correctly reported as **SARS-CoV-2 POSITIVE; Flu A NEGATIVE; Flu B POSITIVE; RSV NEGATIVE**. All 42 negative samples were correctly reported as **SARS-CoV-2 NEGATIVE; Flu A NEGATIVE; Flu B NEGATIVE; RSV NEGATIVE** with the Xpert Xpress CoV-2/Flu/RSV *plus* test. No specimen or amplicon carry-over contamination was observed in this study.



Single-Site Precision

The precision of the Xpert Xpress CoV-2/Flu/RSV *plus* test was established at a single site using a 9-member panel including one negative sample, 4 low positive (~1.5x LoD) samples and 4 moderate positive (~3x LoD) samples. The negative sample consisted of simulated matrix without target microorganism or target RNA. The positive samples were contrived using inactivated NATtrol SARS-CoV-2 (ZeptoMetrix, Buffalo, NY, catalog number NATSARS(COV2)-ST), and cultured viruses Influenza A/Idaho/07/2018, Influenza B/Wisconsin/10/2016, and RSV B/Wash/18537/62 in a simulated NPS/NS matrix.

Testing was conducted over 20 days, using 1 lot of Xpert Xpress CoV-2/Flu/RSV *plus* cartridges at a single site and with 1 operator to yield a total of 80 observations per panel member (1 Site x 1 Operator x 1 Lot x 20 Days x 2 Runs x 2 Replicates = 80 observations/panel member). The results from the study are summarized in [Table 27](#).

Table 27. Summary of the Precision Results by Panel Member – % Agreement

Panel Member	Agreement	% Agreement (95% CI)
Negative	80/80	100% (95.4%-100%)
SARS-CoV-2 Low Positive (~1.5x LoD)	79/80	98.8% (93.3%-99.8%)
SARS-CoV-2 Moderate Positive (~3x LoD)	80/80	100% (95.4%-100%)
Flu A Low Positive (~1.5x LoD)	78/80	97.5% (91.3%-99.3%)
Flu A Moderate Positive (~3x LoD)	80/80	100% (95.4%-100%)
Flu B Low Positive (~1.5x LoD)	77/80	96.3% (89.5%-98.7%)
Flu B Moderate Positive (~3x LoD)	80/80	100% (95.4%-100%)
RSV Low Positive (~1.5x LoD)	78/80	97.5% (91.3%-99.3%)
RSV Moderate Positive (~3x LoD)	80/80	100% (95.4%-100%)

Reproducibility

The reproducibility of the Xpert Xpress CoV-2/Flu/RSV *plus* test was established at 3 sites (2 external and 1 internal) using a 9-member panel including 1 negative sample, 4 low positive (~1.5x LoD) and 4 moderate positive (~3x LoD) samples. The negative sample consisted of simulated matrix without target microorganism or target RNA. The positive samples were contrived using inactivated NATtrol SARS-CoV-2 (ZeptoMetrix), cultured viruses Influenza A/Idaho/07/2018, Influenza B/Wisconsin/10/2016, and RSV B/Wash/18537/62 in a simulated NPS/NS matrix. Testing was conducted over 6 days, using 3 lots of Xpert Xpress CoV-2/Flu/RSV *plus* cartridges at 3 participating sites, each with 2 operators to yield a total of 144 observations per panel member (3 Sites x 2 Operators x 3 Lots x 2 Days/Lot x 2 Runs x 2 Replicates = 144 observations/panel member). The results from the study are summarized in [Table 28](#).



The percent agreement of the correct results compared to the expected results analyzed by each of the 6 operators and each site is shown in Table 28. In addition, the overall percent agreement for each sample (% total agreement) and the two-sided Wilson Score confidence intervals (CI) are presented in the last column.

Table 28. Summary of the Reproducibility Results - % Agreement

Sample	Site 1			Site 2			Site 3			% Total Agreement
	Op 1	Op 2	Site	Op 1	Op 2	Site	Op 1	Op 2	Site	[95% CI]
Negative	100% 24/24	100% 24/24	100% 48/48	100% 24/24	100% 24/24	100% 48/48	100% 24/24	100% 24/24	100% 48/48	100% (144/144) [97.4-100.0]
SARS-CoV-2 Low Pos	100% 24/24	100% 24/24	100% 48/48	100% 24/24	100% 24/24	100% 48/48	100% 24/24	100% 24/24	100% 48/48	100% (144/144) [97.4-100.0]
SARS-CoV-2 Mod Pos	100% 24/24	100% 24/24	100% 48/48	100% 24/24	100% 24/24	100% 48/48	100% 24/24	100% 24/24	100% 48/48	100% (144/144) [97.4-100.0]
Flu A Low Pos	100% 24/24	100% 24/24	100% 48/48	100% 24/24	100% 24/24	100% 48/48	100% 24/24	100% 24/24	100% 48/48	100% (144/144) [97.4-100.0]
Flu A Mod Pos	100% 24/24	100% 24/24	100% 48/48	100% 24/24	100% 24/24	100% 48/48	100% 24/24	100% 24/24	100% 48/48	100% (144/144) [97.4-100.0]
Flu B Low Pos	100% 24/24	100% 24/24	100% 48/48	95.8% 23/24	95.8% 23/24	95.8% 46/48	100% 24/24	100% 24/24	100% 48/48	98.6% (142/144) [95.1-99.6]
Flu B Mod Pos	100% 24/24	100% 24/24	100% 48/48	100% 24/24	100% 24/24	100% 48/48	100% 23/23	95.8% 23/24	97.9% 46/47	99.3% (142/143 ^a) [96.1-99.9]



Sample	Site 1			Site 2			Site 3			% Total Agreement
	Op 1	Op 2	Site	Op 1	Op 2	Site	Op 1	Op 2	Site	[95% CI]
RSV Low Pos	100% 24/24	100% 24/24	100% 48/48	95.8% 23/24	100% 24/24	97.9% 47/48	100% 24/24	100% 24/24	100% 48/48	99.3% (143/144) [96.2-99.9]
RSV Mod Pos	100% 24/24	100% 24/24	100% 48/48	100% 24/24	100% 24/24	100% 48/48	100% 24/24	100% 24/24	100% 48/48	100% (144/144) [97.4-100.0]

- a. One replicate was excluded because it was run on a day when an external positive control produced an incorrect result but was inadvertently not retested.

The evaluation of reproducibility and within-laboratory precision of the underlying analyte Ct values for the Xpert Xpress CoV-2/Flu/RSV *plus* test was analyzed using nested Analysis of Variance (ANOVA). The mean Ct, standard deviation (SD), and coefficient of variation (CV; %) between-sites, between-operators, between-lots, between-days, between-runs and within-run for each panel member are presented in [Table 29](#).



Table 29. Summary of Nested ANOVA by Coefficient of Variation

Sample	Analyte	N	Mean Ct	Variance Source													
				Site		OP		Lot		Day		Run		Within- Run		Total	
				SD	CV (%)	SD	CV (%)	SD	CV (%)	SD	CV (%)	SD	CV (%)	SD	CV (%)	SD	CV (%)
Negative	SPC	144	30.8	0.1	0.4	0.0	0.0	0.9	2.9	0.5	1.5	0.0	0.0	1.3	4.2	1.6	5.3
SARS-CoV-2 Low Pos	SARS-CoV-2	144	37.4	0.0	0.0	0.2	0.5	0.1	0.2	0.0	0.0	0.3	0.7	0.4	1.1	0.5	1.4
SARS-CoV-2 Mod Pos	SARS-CoV-2	144	36.2	0.0	0.1	0.1	0.3	0.0	0.0	0.1	0.3	0.2	0.4	0.4	1.0	0.4	1.2
Flu A Low Pos	Flu A1	144	35.7	0.2	0.6	0.0	0.0	0.1	0.2	0.0	0.0	0.0	0.0	0.6	1.6	0.6	1.7
	Flu A2	135 ^a	37.9	0.3	0.8	0.0	0.0	0.2	0.5	0.0	0.0	0.4	1.1	0.9	2.5	1.1	2.9
Flu A Mod Pos ^b	Flu A1	144	34.7	0.0	0.0	0.1	0.2	0.0	0.0	0.1	0.3	0.0	0.0	0.4	1.2	0.4	1.3
	Flu A2	144	36.6	0.0	0.1	0.0	0.0	0.2	0.4	0.0	0.0	0.0	0.0	0.5	1.5	0.6	1.5
Flu B Low Pos	Flu B	144	36.3	0.3	0.8	0.0	0.1	0.0	0.0	0.1	0.2	0.3	0.7	0.7	2.1	0.8	2.3
Flu B Mod pos	Flu B	142 ^c	35.1	0.0	0.0	0.1	0.4	0.1	0.3	0.3	0.8	0.0	0.0	0.7	2.0	0.8	2.2
RSV Low Pos	RSV	144	35.8	0.1	0.2	0.0	0.0	0.2	0.4	0.0	0.0	0.0	0.0	0.6	1.7	0.6	1.8
RSV Mod Pos	RSV	144	34.8	0.1	0.2	0.0	0.0	0.1	0.4	0.0	0.0	0.2	0.5	0.5	1.4	0.5	1.5

- a. Nine replicates were excluded due to zero Flu A2 Ct values.
- b. One replicate from Site 2 used the reagent lot 102 instead of the intended reagent lot 401. In the nested ANOVA analysis, this replicate was calculated under the intended lot 401 following the principle of “analyze as intended”.
- c. One replicate was excluded due to the zero Flu B Ct value; one replicate was excluded due to an incorrect external positive control result preceding the retest.

? Appendix

Bibliography

1. Centers for Disease Control and Prevention. . Accessed February 9, 2020.
2. bioRxiv. (). Accessed March 3, 2020.
3. Petric M, Comanor L, Petti CA. Role of the laboratory in diagnosis of influenza during seasonal epidemics and potential pandemics. *J Infect Dis.* 2006;194:S98-110.
4. Schweiger B, Zadow I, Heckler R, et al. Application of a fluorogenic PCR assay for typing and subtyping of influenza viruses in respiratory samples. *J Clin Micro.* 2000;38:1552-1558.
5. . Accessed on May 19, 2016.
6. . Accessed on March 14, 2013.
7. Acero-Bedoya, S., Wozniak, P. S., Sánchez, P. J., Ramilo, O., & Mejias, A. (2019). Recent trends in RSV immunoprophylaxis: clinical implications for the infant. *American journal of perinatology*, 36(S 02), S63-S67.
8. Solomon, D. A., Sherman, A. C., & Kanjilal, S. (2020). Influenza in the COVID-19 Era. *Jama*, 324(13), 1342-1343.
9. Centers for Disease Control and Prevention. Biosafety in Microbiological and Biomedical laboratories (refer to latest edition). <http://www.cdc.gov/biosafety/publications/>
10. Clinical and Laboratory Standards Institute. Protection of Laboratory Workers from Occupationally Acquired Infections; Approved Guideline. Document M29 (refer to latest edition).
11. REGULATION (EC) No 1272/2008 OF THE EUROPEAN PARLIAMENT AND OF THE COUNCIL of 16 December 2008 on the classification labeling and packaging of substances and mixtures amending and repealing, List of Precautionary Statements, Directives 67/548/EEC and 1999/45/EC (amending Regulation (EC) No 1907/2007).
12. Occupational Safety and Health Standards, Hazard Communication, Toxic and Hazard Substances (March 26, 2012) (29 C.F.R., pt. 1910, subpt. Z).

Cepheid Headquarters Locations

Corporate Headquarters

Cepheid
904 Caribbean Drive



Sunnyvale, CA 94089
USA

Telephone: + 1 408 541 4191
Fax: + 1 408 541 4192
www.cepheid.com

European Headquarters

Cepheid Europe SAS
Vira Solelh
81470 Maurens-Scopont
France

Telephone: + 33 563 825 300
Fax: + 33 563 825 301
www.cepheidinternational.com

Technical Assistance

Before contacting Cepheid Technical Support, collect the following information:

- Product name
- Lot number
- Serial number of the instrument
- Error messages (if any)
- Software version and, if applicable, Computer Service Tag Number

United States Technical Support





Telephone: + 1 888 838 3222
Email: techsupport@cepheid.com

France Technical Support

Telephone: + 33 563 825 319
Email: support@cepheideurope.com

Contact information for all Cepheid Technical Support offices is available on our website: www.cepheid.com/en/support/contact-us.

Table of Symbols

Symbol	Meaning
	Catalog number
	<i>In vitro</i> diagnostic medical device
	Do not reuse
	Batch code



Symbol	Meaning
	Consult instructions for use
	Caution
	Manufacturer
	Country of manufacture
	Contains sufficient for n tests
	Control
	Expiration date
	Temperature limitation
	Biological risks
	For prescription use only



Cepheid
904 Caribbean Drive
Sunnyvale, CA 94089
USA

Phone: + 1 408 541 4191

Fax: + 1 408 541 4192



Revision History

Description of Changes: 303-1854, Rev. A

Purpose: Initial release