

# Xpert® Carba-R

For use with GeneXpert® System with Touchscreen



## Catalog Numbers

**REF** GXCARBAR-10

303-0945 | Rev. A | 2023-07

**R<sub>x</sub>only** **IVD** In Vitro Diagnostic Medical Device

## Trademark, Patents and Copyright Statements

Cepheid®, the Cepheid logo, GeneXpert®, and Xpert® are trademarks of Cepheid, registered in the U.S. and other countries.

All other trademarks are the property of their respective owners.

THE PURCHASE OF THIS PRODUCT CONVEYS TO THE BUYER THE NON-TRANSFERABLE RIGHT TO USE IT IN ACCORDANCE WITH THESE INSTRUCTIONS FOR USE. NO OTHER RIGHTS ARE CONVEYED EXPRESSLY, BY IMPLICATION OR BY ESTOPPEL. FURTHERMORE, NO RIGHTS FOR RESALE ARE CONFERRED WITH THE PURCHASE OF THIS PRODUCT.

© 2023 Cepheid.

See [Revision History](#) for a description of changes.

# Table of Contents

	<b>Getting Started.....</b>	<b>5</b>
	<b>Product Information.....</b>	<b>5</b>
	Proprietary Name.....	5
	Common or Usual Name .....	5
	<b>Intended Use, Summary, and Principle of Procedure .....</b>	<b>5</b>
	Intended Use.....	5
	Summary and Explanation.....	6
	Principle of the Procedure.....	7
	<b>Reagents, Instruments, and Materials.....</b>	<b>8</b>
	<b>Reagents .....</b>	<b>8</b>
	Materials Provided.....	8
	Materials Required but Not Provided .....	8
	Materials Available but Not Provided.....	9
	<b>Warnings and Precautions .....</b>	<b>9</b>
	<b>Chemical Hazards, Storage and Handling .....</b>	<b>10</b>
	Chemical Hazards.....	11
	Storage and Handling .....	11
	<b>Specimen Collection, Testing, and Results .....</b>	<b>12</b>
	<b>Specimen Collection.....</b>	<b>12</b>
	Specimen Collection, Transport and Storage .....	12
	<b>Procedure .....</b>	<b>13</b>
	Preparing the Cartridge .....	13
	<b>Starting the Test: GeneXpert System with Touchscreen .....</b>	<b>15</b>
	Viewing Results: GeneXpert System with Touchscreen .....	16
	<b>Quality Control .....</b>	<b>16</b>
	<b>Results.....</b>	<b>17</b>
	Reasons to Repeat the Test .....	19
	Rectal and Perirectal Swab Sample Retest Procedure .....	20
	Bacterial Isolate Sample Retest Procedure.....	20
	<b>Limitations .....</b>	<b>20</b>
	General Limitations .....	20
	Rectal and Perirectal Specimen Limitations .....	21
	Pure Colonies Limitations .....	22
	<b>Expected Values .....</b>	<b>22</b>
	<b>Specific Performance Characteristics .....</b>	<b>23</b>
	Clinical Performance – Rectal and Perirectal Swab Specimens .....	23
	Clinical Performance – Bacterial Isolates .....	29

<b>Analytical Performance</b> .....	<b>33</b>
Analytical Sensitivity (Limit of Detection) – Rectal and Perirectal Swabs.....	33
Rectal and Perirectal Swab Matrices Study .....	34
Bacterial Isolate Study.....	38
Analytical Specificity (Cross-Reactivity).....	41
Competitive Interference.....	44
Potentially Interfering Substances.....	45
Carry-over Contamination Study .....	46
Rectal and Perirectal Swab Matrix Study .....	47
Bacterial Isolate Study.....	49

 <b>Appendix</b> .....	<b>52</b>
Bibliography.....	52
Cepheid Headquarters Locations .....	53
Technical Assistance.....	53
Table of Symbols .....	54
Revision History.....	55

# Getting Started

## Product Information

### Proprietary Name

Xpert<sup>®</sup> Carba-R

### Common or Usual Name

Xpert Carba-R

## Intended Use, Summary, and Principle of Procedure

### Intended Use

The Xpert Carba-R test, performed on the GeneXpert<sup>®</sup> Instrument Systems, is a qualitative *in vitro* diagnostic test designed for the detection and differentiation of the *bla*<sub>KPC</sub>, *bla*<sub>NDM</sub>, *bla*<sub>VIM</sub>, *bla*<sub>OXA-48</sub>, and *bla*<sub>IMP</sub> gene sequences associated with carbapenem-non-susceptibility. The test utilizes automated real-time polymerase chain reaction (PCR).

The Xpert Carba-R test is intended as an aid to infection control in the detection of carbapenem-non-susceptible bacteria that colonize patients in healthcare settings. A negative Xpert Carba-R test result does not preclude the presence of other resistance mechanisms.

The Xpert Carba-R test is for use with the following sample types:

### Pure Colonies

The test is performed on carbapenem-non-susceptible pure colonies of *Enterobacteriaceae*, *Acinetobacter baumannii*, or *Pseudomonas aeruginosa*, when grown on blood agar or MacConkey agar. For testing pure colonies, the Xpert Carba-R test should be used in conjunction with other laboratory tests including phenotypic antimicrobial susceptibility testing.

The identification of a *bla*<sub>IMP</sub>, *bla*<sub>NDM</sub>, or *bla*<sub>VIM</sub> metallo-beta-lactamase gene (i.e., the genes that encode the IMP, NDM, and VIM metallo-beta-lactamases, respectively) may be used as an aid to clinicians in determining



appropriate therapeutic strategies for patients with known or suspected carbapenem-non-susceptible bacterial infections.

## Rectal and Perirectal Swab Specimens

The test is performed on rectal and perirectal swab specimens from patients at risk for intestinal colonization with carbapenem-non-susceptible bacteria. Concomitant cultures are necessary to recover organisms for epidemiological typing, antimicrobial susceptibility testing, and for further confirmatory bacterial identification.

The Xpert Carba-R test, when performed on rectal and perirectal swab specimens, is not intended to guide or monitor treatment for carbapenem-non-susceptible bacterial infections or to determine infection from carbapenem-non-susceptible bacteria.

## Summary and Explanation

The global spread of carbapenemase-producing *Enterobacteriaceae*, *Pseudomonas aeruginosa*, and *Acinetobacter* species (i.e., carbapenem non-susceptible organisms, CNSOs) is a critical medical and public health issue.<sup>1,2</sup> These bacteria are often resistant to all beta-lactam agents and frequently are co-resistant to multiple classes of other antimicrobial agents, leaving very few treatment options.<sup>3</sup> Tracing the spread of CNSOs is complicated by the diversity of carbapenem-hydrolyzing enzymes that have emerged and the ability of the genes to spread among multiple bacterial species. Some of the resistance genes, such as the *Klebsiella pneumoniae* carbapenemase (KPC) determinants, are associated with successful clonal lineages of bacteria (e.g., *K. pneumoniae* ST258),<sup>4</sup> which have a selective advantage in hospital settings where antimicrobial use is high. Opportunities for transmission of organisms are often frequent, with further dissemination of the resistance genes via transmissible plasmids and integrons. *K. pneumoniae* strain ST258 has caused multiple epidemics globally, especially in the United States<sup>1</sup> and Israel.<sup>5</sup> Similarly, organisms containing the gene encoding New Delhi metallo-beta-lactamase (NDM) have been introduced into Europe by individuals who, in many cases, have visited India or Pakistan.<sup>6</sup> A third mechanism of carbapenem resistance, mediated by Verona integron-mediated metallo-beta-lactamase (VIM), has been a concern in Europe for several years. Additional metallo-beta-lactamases, such as those in the imipenemase (IMP) class, have been recognized in Japan and other Asian countries for many years, and are now spreading globally.<sup>3</sup> In addition, the Class D oxacillinase, OXA-48, which often mediates low-level carbapenem resistance, is now spreading rapidly in Europe.<sup>7,8</sup>

Currently, the standard method for detecting patients who are colonized with carbapenem-non-susceptible organisms is to culture rectal or perirectal swab samples on gram-negative selective agar plates, such as MacConkey agar, followed by antimicrobial susceptibility testing of lactose fermenting colonies, or by using selective screening agar media.<sup>9</sup> The former is laborious and can require several days to generate a final result, while the latter approach varies considerably in sensitivity and specificity based on the selective medium used.

A fast and accurate method of determining whether a rectal or perirectal swab specimen or a carbapenem-non-susceptible bacterial isolate harbors one of these five common classes of carbapenem resistance genes would be a significant aid to infection control programs especially during outbreaks, since it has the potential to: 1) identify the specific resistance gene present in the organism, and 2) differentiate those organisms with the most common transmissible carbapenem resistance genes that encode carbapenemase enzymes from organisms that are resistant due to other beta-lactamases and/or changes in the organism's cell wall, which may not necessarily require placement of the patient in contact precautions.

The therapeutic challenges associated with carbapenem-resistant *Enterobacteriaceae* have created a heightened awareness for the need of rapid detection and the implementation of effective measures for containment and transmission prevention. Antimicrobial agents, such as new beta-lactam/beta-lactamase inhibitor combinations, have varying activity against bacteria producing different types of beta-lactamases.



Xpert Carba-R test results showing the presence of *bla<sub>IMP</sub>*, *bla<sub>VIM</sub>*, and *bla<sub>NDM</sub>* metallo-beta-lactamase genes from pure colonies of the claimed organisms may be helpful in determining a therapeutic strategy that includes beta-lactam/beta-lactamase inhibitor combinations.<sup>10,11,12,13,14</sup>

## Principle of the Procedure

The GeneXpert Instrument Systems automate and integrate sample preparation, nucleic acid extraction and amplification, and detection of the target sequence in simple or complex samples using real-time PCR tests. The systems consist of an instrument, personal computer, and preloaded software for performing tests and viewing the results. The systems require the use of single-use disposable cartridges that hold the PCR reagents and host the PCR process. Because the cartridges are self-contained, cross-contamination between samples is minimized. For a full description of the system, see the respective operator manual.

The Xpert Carba-R test includes reagents for the detection of *bla<sub>KPC</sub>*, *bla<sub>NDM</sub>*, *bla<sub>VIM</sub>*, *bla<sub>OXA-48</sub>*, and *bla<sub>IMP</sub>* gene sequences as well as a Sample Processing Control (SPC) to control for adequate processing of the target bacteria and to indicate the presence of inhibitor(s) in the PCR reaction. The SPC also ensures that the PCR reaction conditions (temperature and time) are appropriate for the amplification reaction and that the PCR reagents are functional. An additional internal control, the Probe Check Control (PCC), verifies reagent rehydration, PCR tube filling in the cartridge, probe integrity, and dye stability.

The primers and probes in the Xpert Carba-R test detect proprietary sequences for the *bla<sub>KPC</sub>* (KPC), *bla<sub>NDM</sub>* (NDM), *bla<sub>VIM</sub>* (VIM), *bla<sub>OXA-48</sub>* (OXA-48), and *bla<sub>IMP</sub>* (IMP) gene sequences associated with carbapenem-non-susceptibility in gram-negative bacteria.

# Reagents, Instruments, and Materials

## Reagents

### Materials Provided

The Xpert Carba-R Test kit contains sufficient reagents to process 10 samples. The kit contains the following:

#### **Xpert Carba-R Test Cartridges with Integrated Reaction Tubes** 10

- Bead 1, Bead 2, and Bead 3 (freeze-dried) 1 of each per cartridge
- Reagent 1 3 mL per cartridge
- Reagent 2 (Guanidinium chloride) 2.5 mL per cartridge

#### **Xpert Carba-R Test Sample Reagent Vials** 10

- Sample Reagent 5.0 mL per vial

#### **Disposable (1.7 mL) Transfer Pipettes** 10

#### **CD** 1

- Assay Definition Files (ADF)
- Instructions to import ADF into software
- Instructions for Use (Package Insert)

**Note** Safety Data Sheets (SDS) are available at [www.cepheid.com](http://www.cepheid.com) or [www.cepheidinternational.com](http://www.cepheidinternational.com) under the **SUPPORT** tab.

**Note** The bovine serum albumin (BSA) in the beads within this product was produced and manufactured exclusively from bovine plasma sourced in the United States. No ruminant protein or other animal protein was fed to the animals; the animals passed ante- and post-mortem testing. During processing, there was no mixing of the material with other animal materials.

### Materials Required but Not Provided

- GeneXpert system with touchscreen: GeneXpert instrument, touchscreen unit with built-in scanner, Cepheid OS software version 2.0 or higher, and *GeneXpert System with Touchscreen Operator Manual*.





- Specimen Collection Device: Cepheid Catalog Number 900-0370
- Blood Agar (e.g., Remel™ Blood Agar: Catalog Number R01200 or equivalent)
- MacConkey Agar (e.g., Remel™ MacConkey Agar: Catalog Number R01550 or equivalent)
- 10 µg Meropenem discs (e.g., BD BBL™ Sensi-Disc™ Antimicrobial Susceptibility Test Discs, Meropenem, catalog number 231704 or equivalent)
- Sterile forceps
- Disposable, sterile 10 µL inoculating loops (e.g., Copan: Catalog Number COPS-10, or Hardy Diagnostics: Catalog Number L2002A or equivalent)
- Vortex mixer
- Printer: If a printer is required, contact Cepheid Technical support to arrange for the purchase of a recommended printer.

## Materials Available but Not Provided

- Multivalent External Control:  
Xpert Carba-R QC Panel M219, catalog number M219 from Maine Molecular Quality Controls, Inc. (MMQCI, Scarborough, ME), as external positive control (inactivated *Escherichia coli* carrying plasmid with KPC, NDM, VIM, IMP, OXA-48 gene sequences) and external negative control (inactivated *E. coli*).
- Individual External Controls:  
Carbapenemase-producing bacteria *K. pneumoniae* KPC-2 (catalog number ATCC BAA-1705); *K. pneumoniae* NDM-1 (catalog number ATCC BAA-2146); *K. pneumoniae* VIM-1 (catalog number NCTC 13439); *K. pneumoniae* OXA-48 (catalog number NCTC 13442); and *Escherichia coli* IMP-1 (catalog number NCTC 13476) as external positive controls.

## Warnings and Precautions

- For *in vitro* diagnostic use. 
- Treat all biological specimens, including used cartridges, as if capable of transmitting infectious agents. Because it is often impossible to know which might be infectious, all biological specimens should be treated with standard precautions. Guidelines for specimen handling are available from the U.S. Centers for Disease Control and Prevention<sup>15,16</sup> and the Clinical and Laboratory Standards Institute.<sup>17</sup>
- Follow your institution's safety procedures for working with chemicals and handling biological samples/agar plates with pure colonies.
- Biological specimens, transfer devices, and used cartridges should be considered capable of transmitting infectious agents requiring standard precautions. Follow your institution's environmental waste procedures for proper disposal of used cartridges and unused reagents. These materials may exhibit characteristics of chemical hazardous waste requiring specific national or regional disposal procedures. If national or regional regulations do not provide clear direction on proper disposal, biological specimens and used cartridges should be disposed per WHO [World Health Organization] medical waste handling and disposal guidelines.
- Good laboratory practices, including changing gloves between handling samples, are recommended to avoid contamination of samples or reagents.
- Do not substitute Xpert Carba-R Sample Reagent with other reagents.
- Do not open the Xpert Carba-R cartridge lid until you are ready to add the sample.



- Do not use a cartridge that has been dropped after removing it from the packaging.

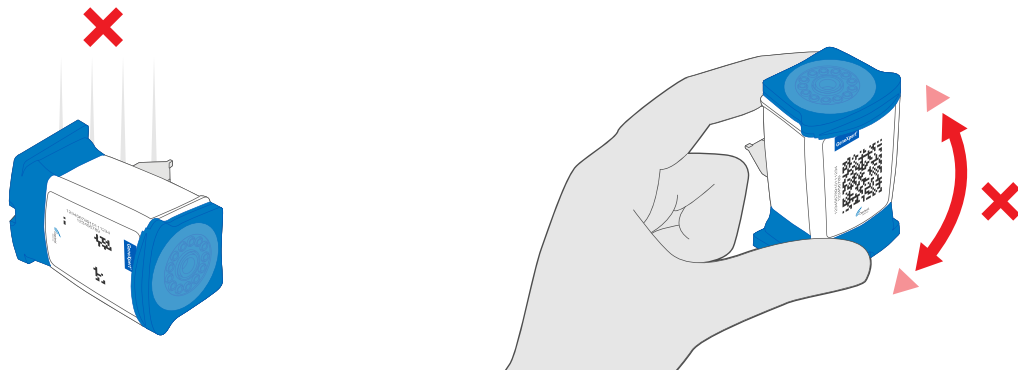

- Do not shake the cartridge. Shaking or dropping the cartridge after opening the cartridge lid may yield invalid results.
- Do not place the sample ID label on the cartridge lid or on the bar code label.



- Each single-use Xpert Carba-R cartridge is used to process one test. Do not reuse spent cartridges.
- Do not use a cartridge that has a damaged reaction tube.

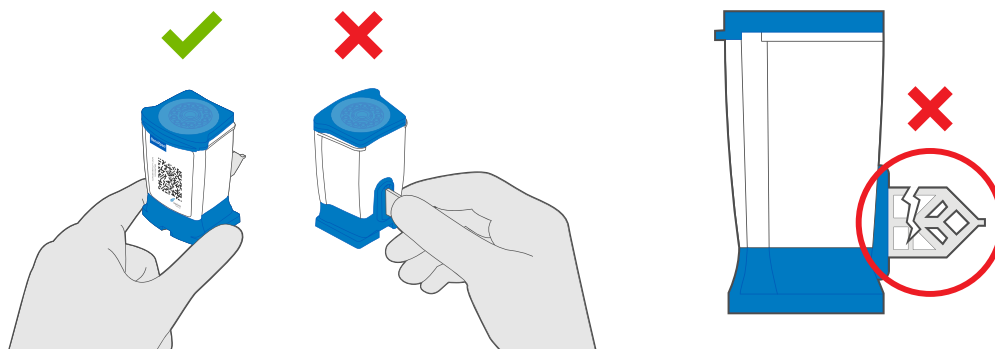

- Wear clean lab coats and gloves. Change gloves between processing each sample.
- In the event of contamination of the work area or equipment with samples or controls, thoroughly clean the contaminated area with a solution of 1:10 dilution of household chlorine bleach and then repeat the cleaning of the work area with 70% ethanol. Wipe work surfaces dry completely before proceeding.

## Chemical Hazards, Storage and Handling



## Chemical Hazards<sup>18,19</sup>

- UN GHS Hazard Pictogram:
- Signal Word: WARNING
- **UN GHS Precautionary Statements**
  - **Prevention**
    - Wash thoroughly after handling.
    - Wear protective gloves/protective clothing/eye protection/face protection.
  - **Response**
    - IF ON SKIN: Wash with plenty of soap and water.
    - Specific treatment, see supplemental first aid information.
    - Take off contaminated clothing and wash before reuse.
    - If skin irritation occurs: Get medical advice/attention.
    - IF IN EYES: Rinse cautiously with water for several minutes. Remove contact lenses, if present and easy to do. Continue rinsing.
    - If eye irritation persists: Get medical advice/attention.
    - Call a POISON CENTER or doctor/physician if you feel unwell.

## Storage and Handling

- Store the Xpert Carba-R cartridges at 2–28 °C.
- Do not open a cartridge lid until you are ready to perform testing.
- Do not use reagents or cartridges that have passed the expiration date.
- The Sample Reagent is a clear, colorless liquid. Do not use the Sample Reagent if it has become cloudy or discolored.
- Use the cartridge within 30 minutes after opening the cartridge lid.
- Do not use a cartridge that has leaked.

# 📄 Specimen Collection, Testing, and Results

## Specimen Collection

### Specimen Collection, Transport and Storage

#### Rectal or Perirectal Swab Samples:

For swabs to be used, see .

- Collection of a paired rectal swab: Carefully insert both swab tips approximately 1 cm beyond the anal sphincter and rotate gently. See for the swabs to be used and [Figure 1](#) and [Figure 2](#) for examples of acceptable and unacceptable swabs for use with the Xpert Carba-R Test.
- Collection of a paired perirectal swab: Carefully insert both swab tips no more than 1 cm into the anal opening before the anal sphincter and rotate gently.
- Swabs in the transport tube can be stored at 15–28 °C for up to five days.
- [Figure 1](#) below provides examples of the acceptable swab specimens to be used with the Xpert Carba-R Test, and [Figure 2](#) provides examples of highly soiled swab specimens that should not be used with the Xpert Carba-R Test.

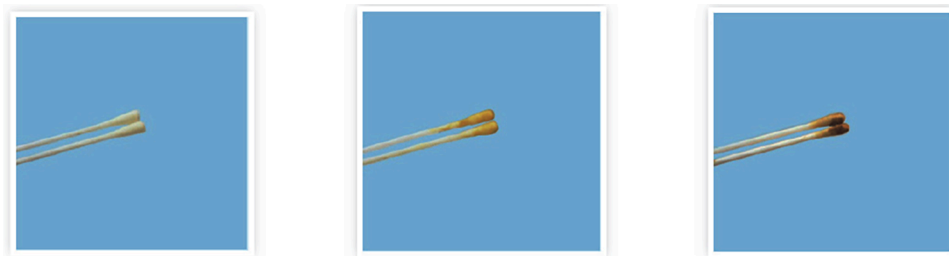

*Figure 1 Examples of Acceptable Swab Specimens for Xpert Carba-R Testing*

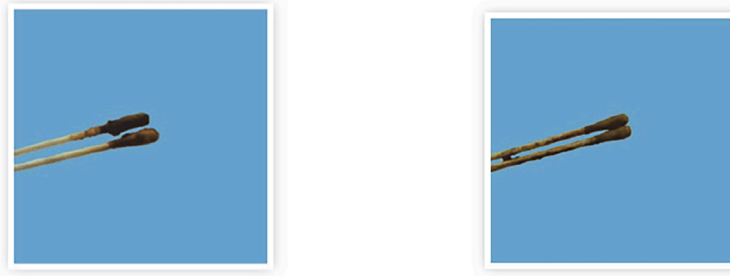

Figure 2 Examples of Unacceptable Swab Specimens for Xpert Carba-R Test Testing

## Bacterial Isolates:

1. Organisms should be identified and carbapenem non-susceptibility status should be determined in accordance with the current FDA approved drug instructions for use and the latest version of CLSI guideline M100<sup>20</sup> prior to testing on Xpert Carba-R Test.
2. Inoculate the organism onto either a blood or MacConkey agar plate, streak for isolation, and place a 10 µg meropenem disk in the first streak quadrant as a means to ensure that the isolate retains its non-susceptibility to carbapenem.
3. Incubate the plate at 35 °C for 18–24 hours in ambient air.
4. Use the direct colony suspension method by touching isolated colonies with a swab or loop to prepare a 0.5 McFarland suspension of the bacterial isolate as outlined in the CLSI M07 Approved Standard<sup>21</sup>. The steps are also described below.
  - a. Make a suspension of isolated colonies selected from an agar plate (e.g., a nonselective medium such as blood agar that has been incubated for 18 hours to 24 hours) directly in broth or saline.
  - b. Adjust the suspension to achieve a turbidity equivalent to a 0.5 McFarland standard. This results in a suspension containing approximately  $1 \text{ to } 2 \times 10^8$  CFU/mL for *E. coli* ATCC (American Type Culture Collection) 25922.
  - c. Use either a photometric device or, if performed visually, use adequate light to compare the inoculum tube and the 0.5 McFarland standard against a card with a white background and contrasting black lines.

## Procedure

### Preparing the Cartridge

**i** **Important** Place the cartridge into the GeneXpert instrument within 30 minutes of adding the sample to the cartridge.

1. Remove a Xpert Carba-R test cartridge, a Sample Reagent vial and a transfer pipette from the kit. Open the vial of the Sample Reagent.
2. To add the sample to the cartridge:
  - For rectal or perirectal swab samples, to add the swab sample to the cartridge:
    - From the paired swabs, place one swab into the Sample Reagent vial. Replace the unused swab into the transport tube and store.

**Note** Refer to [Specimen Collection, Transport and Storage](#) for storage conditions of the rectal or perirectal swab samples. The leftover second swab may be used for repeat testing.



**Note** Refer to [Rectal and Perirectal Swab Sample Retest Procedure](#) to repeat the test for rectal or perirectal swab samples.

- Hold the swab by the stem near the rim of the vial, lift the swab a few millimeters from the bottom of the vial and bend the stem over the edge of the vial to break it off at the score mark, leaving the swab short enough to allow the swab to fit into the vial and to allow the cap to close tightly.
- For bacterial isolates, to add the 0.5 McFarland suspension of the isolate to the cartridge:
  - Vortex the 0.5 McFarland suspension. Using a 10  $\mu$ L loop, transfer 10  $\mu$ L of the 0.5 McFarland suspension to a 5 mL vial of Sample Reagent. Swirl the loop a minimum of three times in the Sample Reagent. After the initial test, the leftover sample in the Sample Reagent vial can be retained at 2–28 °C for up to five days if a retest is required.

**Note** Refer to [Bacterial Isolate Sample Retest Procedure](#) for instructions on how to repeat the test for bacterial isolate samples.

**Note** Ensure that the 10  $\mu$ L loop is filled with sample and the sample suspension in the loop does not burst when transferring the 0.5 McFarland suspension to the Sample Reagent.

3. Cap the Sample Reagent vial tightly and vortex at high speed for 10 seconds.
4. Open the cartridge lid. Open the Sample Reagent cap. Using the transfer pipette provided, aspirate the prepared sample (Sample Reagent containing the sample from Step 2) up to the mark on the pipette (which is approximately 1.7 mL; see [Figure 3](#)) and then transfer the material into the Sample Chamber large opening (see [Figure 4](#)) of the Xpert Carba-R Test cartridge.
5. Close the cartridge lid and place the cartridge into the GeneXpert instrument within 30 minutes of adding the sample to the cartridge.

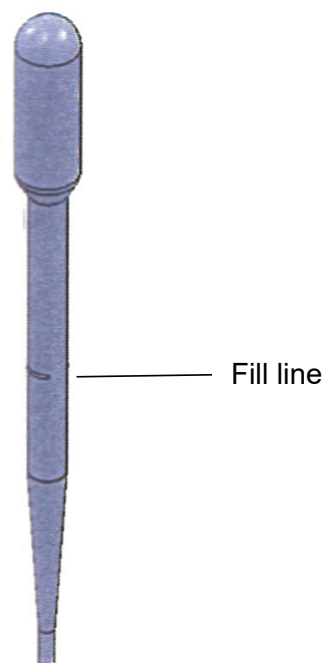

*Figure 3 Transfer Pipette to Transfer Sample to Cartridge*

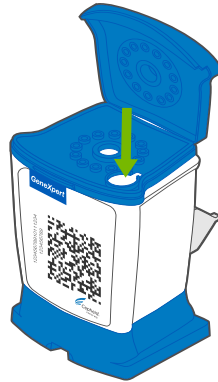

Figure 4 Xpert Carba-R Test Cartridge (Top View)

## Starting the Test: GeneXpert System with Touchscreen

**i Important** Before you start the test, make sure that:

- The system is running the correct Cepheid OS software version shown in section - **Materials Required but Not Provided.**
- The correct assay definition file is imported into the software.

**Note** The default workflow is shown. Your system administrator may alter the workflow.

1. Turn on GeneXpert system with touchscreen.
2. Log on to system software using your username and password.
3. On the Modules tab, touch **Start Test**.
4. Follow onscreen prompts to create new test and enter patient and sample information.
5. Scan or manually input the cartridge serial number. If scanning, hold the cartridge about 1-3 inches (3-7 cm) away from the scanner. The scanner projects a green crosshair, which you center on the barcode. Scanning is complete when you hear an audible beep. Touch **Continue**.

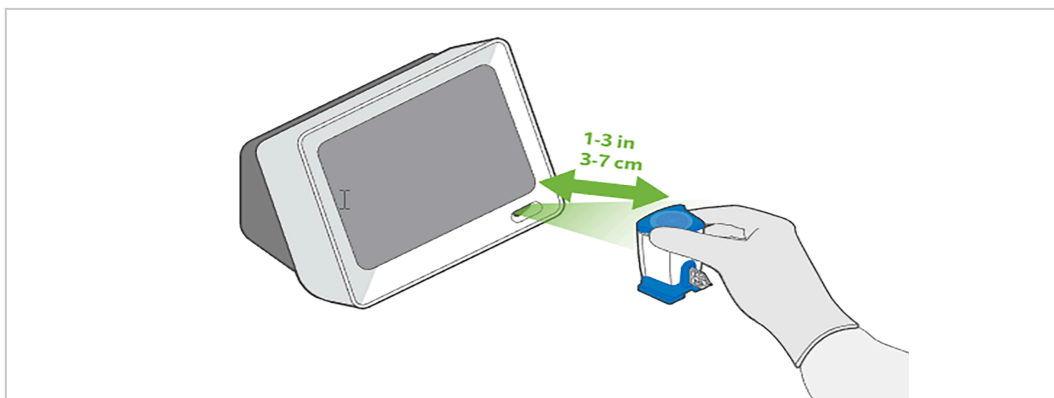

6. Select the desired test and touch **Continue**.
7. Watch the cartridge preparation video, if needed.
8. On the Confirm screen, review all data and touch **Confirm**.
9. Open the module door under flashing green light and insert the cartridge.

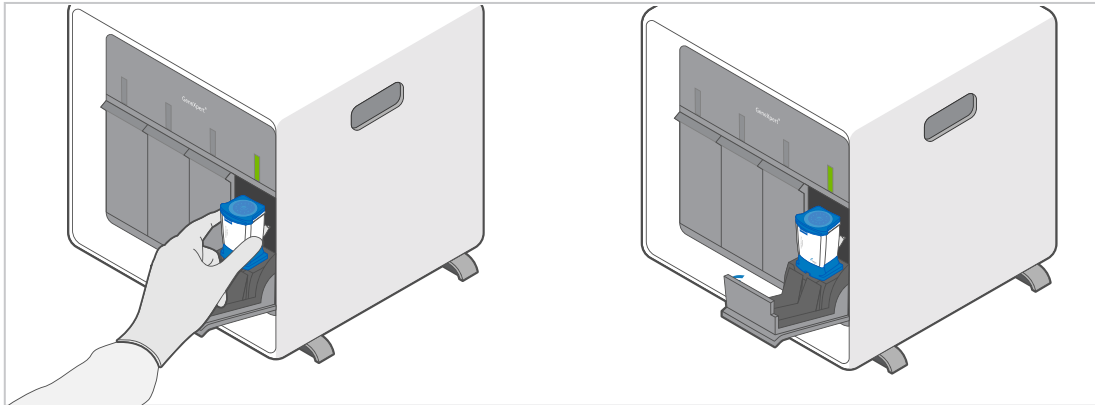

10. Close cartridge module door completely by pressing until it latches. The test starts.

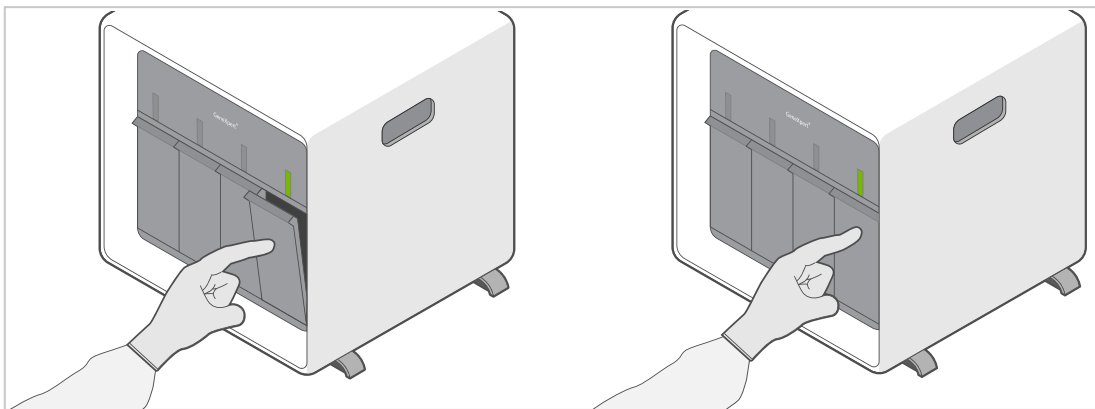

11. When the test completes, the **Results Summary** screen appears. Open the module door and remove cartridge.
12. Dispose of used cartridge in appropriate waste container according to your institution's standard practices.

## Viewing Results: GeneXpert System with Touchscreen

The GeneXpert system with touchscreen results screen will automatically interpret test results for you and clearly show them in the **View Results** window.

1. Tap **Results**.
2. Tap the test to be viewed in the Results screen.
3. Click **OK**.
4. To generate a PDF report file, touch **View Report**. More detailed instructions for viewing and uploading results are available in your system operator manual.

## Quality Control

### Built-in Quality Controls

Each test includes a Sample Processing Control and a Probe Check Control.

- **Sample Processing Control (SPC)**—Ensures the sample was processed correctly. The SPC that is included in each cartridge verifies adequate processing of the sample. The SPC verifies that lysis of bacteria has occurred if the organisms are present and verifies that sample processing is adequate. Additionally, this





control detects sample-associated inhibition of the real-time PCR test, ensures the PCR reaction conditions (temperature and time) are appropriate for the amplification reaction, and that the PCR reagents are functional.

The SPC should be positive in a negative sample and can be negative or positive in a positive sample. The SPC passes if it meets the validated acceptance criteria.

- **Probe Check Control (PCC)**—Before the start of the PCR reaction, the GeneXpert System measures the fluorescence signal from the probes to monitor bead rehydration, reaction tube filling, probe integrity, and dye stability. Probe Check passes if it meets the assigned acceptance criteria.

### External Controls

External controls described in [Materials Available but Not Provided](#) and may be used in accordance with local, state, and federal accrediting organizations, as applicable. Always use external controls, according to the manufacturer’s instructions.

## Results

The results are interpreted by the GeneXpert System from measured fluorescent signals and embedded calculation algorithms and will be shown in the **View Results** window. Screenshots and interpretations for all possible combinations of results with the five target analytes in the Xpert Carba-R test are not shown; however, the following examples are indicative of the type of results that can be expected.

**Note** The following table shows only representative examples of the types of results that can be expected with the Xpert Carba-R test. Not all possible combinations of results with the five target analytes are shown.

**Table 1. Xpert Carba-R Representative Results and Interpretation**

Result	Interpretation
IMP DETECTED; VIM NOT DETECTED; NDM NOT DETECTED; KPC NOT DETECTED; OXA48 NOT DETECTED	<p>IMP target DNA sequence is detected; VIM, NDM, KPC, and OXA-48 target DNA sequences are not detected.</p> <ul style="list-style-type: none"> <li>• PCR amplification of the IMP target DNA gives a Ct value within the valid range and a fluorescence endpoint above the threshold setting; VIM, NDM, KPC, and OXA-48 target DNA sequences are absent or below the test detection level.</li> <li>• SPC: Not applicable. The SPC is ignored because IMP target DNA amplification may compete with this control.</li> <li>• PCC: PASS; all probe check results pass.</li> <li>• Therapeutic strategies that include antimicrobial agents, such as beta-lactam/beta-lactamase inhibitor combinations with limited or no activity against bacteria producing metallo-beta-lactamases, should be used with caution. Xpert Carba-R test results showing the presence of <i>bla</i><sub>IMP</sub>, <i>bla</i><sub>VIM</sub>, and <i>bla</i><sub>NDM</sub> metallo-beta-lactamase genes from pure colonies of the claimed organisms may be helpful in determining a therapeutic strategy in patients with known or suspected carbapenem-non-susceptible bacterial infections.</li> </ul>
IMP NOT DETECTED; VIM DETECTED; NDM NOT DETECTED; KPC NOT DETECTED; OXA48 NOT DETECTED	<p>VIM target DNA sequence is detected; IMP, NDM, KPC, and OXA-48 target DNA sequences are not detected.</p> <ul style="list-style-type: none"> <li>• PCR amplification of the VIM target DNA gives a Ct value within the valid range and a fluorescence endpoint above the threshold setting; IMP, NDM, KPC, and OXA-48 target DNA sequences are absent or below the test detection level.</li> <li>• SPC: Not applicable. The SPC is ignored because VIM target DNA amplification may compete with this control.</li> <li>• PCC: PASS; all probe check results pass.</li> <li>• Therapeutic strategies that include antimicrobial agents, such as beta-lactam/beta-lactamase inhibitor combinations with limited or no activity against bacteria producing metallo-beta-lactamases, should be used with caution. Xpert Carba-R test results showing the presence of <i>bla</i><sub>IMP</sub>, <i>bla</i><sub>VIM</sub>, and <i>bla</i><sub>NDM</sub> metallo-beta-lactamase genes from pure colonies of the claimed organisms may be helpful in determining a therapeutic strategy in patients with known or suspected carbapenem-non-susceptible bacterial infections.</li> </ul>



Result	Interpretation
<p>IMP NOT DETECTED; VIM DETECTED; NDM DETECTED; KPC NOT DETECTED; OXA48 NOT DETECTED</p>	<p>VIM and NDM target DNA sequences are detected; IMP, KPC, and OXA-48 target DNA sequences are not detected.</p> <ul style="list-style-type: none"> <li>• PCR amplification of the VIM and NDM target DNAs give Ct values within the valid ranges and fluorescence endpoints above the threshold settings; IMP, KPC, and OXA-48 target DNA sequences are absent or below the test detection level.</li> <li>• SPC: Not applicable. The SPC is ignored because VIM and NDM target DNA amplifications may compete with this control.</li> <li>• PCC: PASS; all probe check results pass.</li> <li>• Therapeutic strategies that include antimicrobial agents, such as beta-lactam/beta-lactamase inhibitor combinations with limited or no activity against bacteria producing metallo-beta-lactamases, should be used with caution. Xpert Carba-R test results showing the presence of <i>bla</i><sub>IMP</sub>, <i>bla</i><sub>VIM</sub>, and <i>bla</i><sub>NDM</sub> metallo-beta-lactamase genes from pure colonies of the claimed organisms may be helpful in determining a therapeutic strategy in patients with known or suspected carbapenem-non-susceptible bacterial infections.</li> </ul>
<p>IMP DETECTED; VIM NOT DETECTED; NDM DETECTED; KPC NOT DETECTED; OXA48 NOT DETECTED</p>	<p>IMP and NDM target DNA sequences are detected; VIM, KPC, and OXA-48 target DNA sequences are not detected.</p> <ul style="list-style-type: none"> <li>• PCR amplification of the IMP and NDM target DNAs give Ct values within the valid ranges and fluorescence endpoints above the threshold settings; VIM, KPC, and OXA-48 target DNA sequences are absent or below the test detection level.</li> <li>• SPC: Not applicable. The SPC is ignored because IMP and NDM target DNA amplifications may compete with this control.</li> <li>• PCC: PASS; all probe check results pass.</li> <li>• Therapeutic strategies that include antimicrobial agents, such as beta-lactam/beta-lactamase inhibitor combinations with limited or no activity against bacteria producing metallo-beta-lactamases, should be used with caution. Xpert Carba-R test results showing the presence of <i>bla</i><sub>IMP</sub>, <i>bla</i><sub>VIM</sub>, and <i>bla</i><sub>NDM</sub> metallo-beta-lactamase genes from pure colonies of the claimed organisms may be helpful in determining a therapeutic strategy in patients with known or suspected carbapenem-non-susceptible bacterial infections.</li> </ul>
<p>IMP DETECTED; VIM DETECTED; NDM NOT DETECTED; KPC NOT DETECTED; OXA48 DETECTED</p>	<p>IMP, VIM, and OXA-48 target DNA sequences are detected; NDM and KPC target DNA sequences are not detected.</p> <ul style="list-style-type: none"> <li>• PCR amplification of the IMP, VIM, and OXA-48 target DNAs give Ct values within the valid ranges and fluorescence endpoints above the threshold settings; KPC and NDM target DNA sequences are absent or below the test detection level.</li> <li>• SPC: Not applicable. The SPC is ignored because IMP, VIM, and OXA-48 target DNA amplifications may compete with this control.</li> <li>• PCC: PASS; all probe check results pass.</li> <li>• Therapeutic strategies that include antimicrobial agents, such as beta-lactam/beta-lactamase inhibitor combinations with limited or no activity against bacteria producing metallo-beta-lactamases, should be used with caution. Xpert Carba-R test results showing the presence of <i>bla</i><sub>IMP</sub>, <i>bla</i><sub>VIM</sub>, and <i>bla</i><sub>NDM</sub> metallo-beta-lactamase genes from pure colonies of the claimed organisms may be helpful in determining a therapeutic strategy in patients with known or suspected carbapenem-non-susceptible bacterial infections.</li> </ul>
<p>IMP DETECTED; VIM DETECTED; NDM DETECTED; KPC NOT DETECTED; OXA48 DETECTED</p>	<p>IMP, VIM, NDM, and OXA-48 target DNA sequences are detected; KPC target DNA sequence is not detected.</p> <ul style="list-style-type: none"> <li>• PCR amplification of the IMP, VIM, NDM, and OXA-48 target DNAs give Ct values within the valid ranges and fluorescence endpoints above the threshold settings; the KPC target DNA sequence is absent or below the test detection level.</li> <li>• SPC: Not applicable. The SPC is ignored because IMP, VIM, NDM, and OXA-48 target DNA amplifications may compete with this control.</li> <li>• PCC: PASS; all probe check results pass.</li> <li>• Therapeutic strategies that include antimicrobial agents, such as beta-lactam/beta-lactamase inhibitor combinations with limited or no activity against bacteria producing metallo-beta-lactamases, should be used with caution. Xpert Carba-R test results showing the presence of <i>bla</i><sub>IMP</sub>, <i>bla</i><sub>VIM</sub>, and <i>bla</i><sub>NDM</sub> metallo-beta-lactamase genes from pure colonies of the claimed organisms may be helpful in determining a therapeutic strategy in patients with known or suspected carbapenem-non-susceptible bacterial infections.</li> </ul>



Result	Interpretation
<b>IMP DETECTED; VIM DETECTED; NDM DETECTED; KPC DETECTED; OXA48 DETECTED</b>	<p>IMP, VIM, NDM, KPC, and OXA-48 target DNA sequences are detected.</p> <ul style="list-style-type: none"> <li>• PCR amplification of the IMP, VIM, NDM, KPC, and OXA-48 target DNAs give Ct values within the valid ranges and fluorescence endpoints above the threshold settings.</li> <li>• SPC: Not applicable. The SPC is ignored because IMP, VIM, NDM, KPC, and OXA-48 target DNA amplifications may compete with this control.</li> <li>• PCC: PASS; all probe check results pass.</li> <li>• Therapeutic strategies that include antimicrobial agents, such as beta-lactam/beta-lactamase inhibitor combinations with limited or no activity against bacteria producing metallo-beta-lactamases, should be used with caution. Xpert Carba-R test results showing the presence of <i>bla</i><sub>IMP</sub>, <i>bla</i><sub>VIM</sub>, and <i>bla</i><sub>NDM</sub> metallo-beta-lactamase genes from pure colonies of the claimed organisms may be helpful in determining a therapeutic strategy in patients with known or suspected carbapenem-non-susceptible bacterial infections.</li> </ul>
<b>IMP NOT DETECTED; VIM NOT DETECTED; NDM NOT DETECTED; KPC NOT DETECTED; OXA48 NOT DETECTED</b>	<p>IMP, VIM, NDM, KPC, and OXA-48 target DNA sequences are not detected.</p> <ul style="list-style-type: none"> <li>• IMP, VIM, NDM, KPC, and OXA-48 target DNA sequences are absent or below the test detection level.</li> <li>• SPC: PASS; PCR amplification of the SPC DNA sequence gives a Ct value within the valid range and a fluorescence endpoint above the threshold setting.</li> <li>• PCC: PASS; all probe check results pass.</li> </ul>
<b>INVALID</b>	<p>Presence or absence of IMP, VIM, NDM, KPC, and OXA-48 target DNA sequences cannot be determined. Use the instructions in to repeat the test.</p> <ul style="list-style-type: none"> <li>• SPC: FAIL; No PCR amplification of the SPC DNA sequence or the SPC Ct is not within valid range and the fluorescence endpoint is below threshold setting.</li> <li>• PCC: PASS; all probe check results pass.</li> </ul>
<b>ERROR</b>	<p>Presence or absence of IMP, VIM, NDM, KPC, and OXA-48 target DNA sequences cannot be determined. Use the instructions in , to repeat the test.</p> <ul style="list-style-type: none"> <li>• SPC: NO RESULT</li> <li>• PCC: FAIL*; one or more of the probe check results failed. The PCC probably failed because the reaction tube was filled improperly or a probe integrity problem was detected.</li> </ul> <p>* If the probe check passed, the error is caused by a system component failure.</p>
<b>NO RESULT</b>	<p>Presence or absence of IMP, VIM, NDM, KPC, and OXA-48 target DNA sequences cannot be determined. Use the instructions in , to repeat the test. Insufficient data were collected to produce a test result (for example, the operator stopped a test that was in progress or a power failure occurred).</p> <ul style="list-style-type: none"> <li>• SPC: NO RESULT</li> <li>• PCC: Not applicable</li> </ul>

**Note** Examples of NDM positive, KPC positive, and OXA positive samples are not shown.

## Reasons to Repeat the Test

Repeat the test using a new cartridge (do not re-use the cartridge) and new Sample Reagent vial. For the retest procedure, see .

- An **INVALID** result indicates that the control SPC failed. The sample was not properly processed or PCR is inhibited, or the volume of sample added was inadequate.
- An **ERROR** result indicates that the Probe Check control failed and the test was aborted possibly due to the reaction tube being filled improperly, a reagent probe integrity problem was detected, because the maximum pressure limits were exceeded, or a valve positioning error was detected.
- A **NO RESULT** indicates that insufficient data were collected. For example, the operator stopped a test that was in progress or a power failure occurred.



- If an External Control fails to perform as expected, repeat external control test and/or contact Cepheid Technical Support for assistance.

## Rectal and Perirectal Swab Sample Retest Procedure

1. Remove a new cartridge, a new Sample Reagent vial, and a new transfer pipette from the kit.
2. Remove the leftover swab from the transport container.
3. Insert the swab into a new Sample Reagent vial. Hold the swab by the stem near the rim of the vial, lift the swab a few millimeters from the bottom of the vial and bend the stem over the edge of the vial to break it off at the score mark, leaving the swab short enough to allow the swab to fit into the vial and to allow the cap to close tightly.
4. Cap the new Sample Reagent vial tightly and vortex at high speed for 10 seconds.
5. Open the cartridge lid. Using the provided transfer pipette, aspirate the Sample Reagent to the mark on the pipette, and then transfer the material into the Sample Chamber of the Xpert Carba-R Test cartridge.
6. Close the cartridge lid and place the cartridge into the GeneXpert instrument within 30 minutes. Follow [Starting the Test: GeneXpert System with Touchscreen](#).

## Bacterial Isolate Sample Retest Procedure

1. Remove a new cartridge, a new Sample Reagent vial, and a new transfer pipette from the kit.
2. Transfer the entire contents of the leftover sample in the Sample Reagent vial to the new Sample Reagent vial.
3. Cap the new Sample Reagent vial tightly and vortex at high speed for 10 seconds.
4. Open the cartridge lid. Using the provided transfer pipette, aspirate the Sample Reagent to the mark on the pipette, and then transfer the material into the Sample Chamber of the Xpert Carba-R Test cartridge.
5. Close the cartridge lid and place the cartridge into the GeneXpert instrument within 30 minutes. Follow [Starting the Test: GeneXpert System with Touchscreen](#).

**Note** For bacterial isolates, do not perform the retest procedure more than once as repeated dilutions may give false negative results.

## Limitations

### General Limitations

- The Xpert Carba-R test detects *bla<sub>KPC</sub>*, *bla<sub>NDM</sub>*, *bla<sub>VIM</sub>*, *bla<sub>OXA-48</sub>*, and *bla<sub>IMP</sub>* from rectal and perirectal swab specimens and pure colonies, and is not for bacterial identification. Detection of these gene sequences does not indicate the presence of viable organisms.
- The Xpert Carba-R test is not a sub-typing tool and does not report variants of the *bla<sub>IMP</sub>*, *bla<sub>VIM</sub>*, *bla<sub>NDM</sub>*, *bla<sub>KPC</sub>*, or *bla<sub>OXA-48</sub>* genes.
- Certain bacterial species, such as *Pseudomonas aeruginosa* and *Acinetobacter baumannii* have been shown to exhibit resistance to carbapenems due to intrinsic resistance mechanisms.
- The detection of other OXA-carbapenemase genes, besides *bla<sub>OXA-48</sub>* and *bla<sub>OXA-181</sub>*, has not been evaluated in the study.
- The *in silico* analyses used to predict variants detected by the test were based on a comparison of target gene sequences available in GenBank to the Xpert Carba-R test primer/probe oligonucleotides and amplicon



sequence for each gene target. BLAST searches for *in silico* analysis were performed in 2014-2015. *In silico* analysis of new variant gene sequences deposited into the database after 2015 for the five target genes have not been performed.

- Mutations or polymorphisms in primer or probe binding regions may affect detection of current, new or unknown *bla*<sub>KPC</sub>, *bla*<sub>NDM</sub>, *bla*<sub>VIM</sub>, *bla*<sub>OXA-48</sub>, and *bla*<sub>IMP</sub> variants, resulting in a false negative result.
- The Xpert Carba-R test will generate a negative IMP result when testing samples containing IMP-7, IMP-13, or IMP-14 gene sequences.
- Performance of the Xpert Carba-R test with non-target carbapenemase genes, other than *bla*<sub>SPM</sub>, *bla*<sub>SME</sub>, and *bla*<sub>IMI</sub>, is unknown.
- As the detection of *bla*<sub>KPC</sub>, *bla*<sub>NDM</sub>, *bla*<sub>VIM</sub>, *bla*<sub>OXA-48</sub>, and *bla*<sub>IMP</sub> gene sequences is dependent on the number of organisms present in the sample, reliable results are dependent on proper sample handling and storage.
- Testing with the Xpert Carba-R test should be used as an adjunct to other available methods.
- Xpert Carba-R test results may sometimes be **INVALID** due to a failed SPC control, or result in an **ERROR** or **NO RESULT**, and require retesting that can lead to a delay in obtaining final results.

## Rectal and Perirectal Specimen Limitations

- The performance of the Xpert Carba-R test has not been evaluated with rectal or perirectal swab specimens from pediatric patients.
- Analytical studies using combinations of two bacterial populations on contrived swab specimens indicate that when one carbapenemase-producing bacterial species is inoculated near the LoD and another carbapenemase-producing bacterial species is present at concentrations equal or greater than  $5 \times 10^6$  CFU/swab, the low concentration target may not be detected. Co-colonization with two or more carbapenemase-producing organisms has been reported with Xpert Carba-R test, but is rare. Lack of detection of a second target should have a minimal impact on patient management since isolation procedures would be instituted for patients showing any positive result for a carbapenemase-producing organism.
- Interference with the Xpert Carba-R test may be observed with barium sulfate at > 0.1% w/v and Pepto-Bismol at > 0.01% w/v in tests with rectal swab matrix samples.
- Interference with the Xpert Carba-R test may be observed with barium sulfate at > 0.1% w/v and Pepto-Bismol at > 0.025% w/v in tests with perirectal swab matrix samples.
- In rectal swab samples containing the VIM target, interference may occur if fecal fat is present at a concentration of 0.25% w/v, resulting in delayed cycle threshold values.
- In addition to *Pseudomonas aeruginosa* and *Acinetobacter baumannii* groups tested in the contrived study, other non-*Enterobacteriaceae* were also evaluated: *Pseudomonas stutzeri* (1), *Pseudomonas oryzae* (1), *Pseudomonas putida* (2), and *Empedobacter brevis* (1). The performance of the Xpert Carba-R test with other non-*Enterobacteriaceae* besides these six species has not been evaluated and is therefore unknown.
- For rectal swab specimens, the Xpert Carba-R test showed reduced positive percent agreement (PPA of 55.6%) for detection of the *bla*<sub>VIM</sub> gene sequence in *Pseudomonas aeruginosa*. Four (4) false negative results were observed with the test in specimens in which *Pseudomonas aeruginosa* containing the *bla*<sub>VIM</sub> sequence was recovered by the reference method.
- For rectal swab specimens, the Xpert Carba-R test showed reduced positive percent agreement (PPA of 85.7%) for the detection of the *bla*<sub>IMP</sub> gene sequence in *Acinetobacter baumannii* during the Contrived Study. In addition, a low % total agreement (86.1%) across sites for the Reproducibility Study was observed with samples containing low concentrations of organism harboring the *bla*<sub>IMP</sub> gene sequence.
- Carbapenem-resistant anaerobes potentially present in fecal specimens have not been evaluated by the Xpert Carba-R test.
- The detection of *bla*<sub>KPC</sub>, *bla*<sub>NDM</sub>, *bla*<sub>VIM</sub>, *bla*<sub>OXA-48</sub>, and/or *bla*<sub>IMP</sub> from rectal and perirectal swab



specimens may be from organisms other than *Enterobacteriaceae*, *Pseudomonas aeruginosa* and *Acinetobacter baumannii*.

- The performance of the Xpert Carba-R test with susceptible isolates containing *bla*<sub>KPC</sub>, *bla*<sub>NDM</sub>, *bla*<sub>VIM</sub>, *bla*<sub>OXA-48</sub>, and/or *bla*<sub>IIMP</sub> gene sequences has not been fully evaluated.

## Pure Colonies Limitations

- For pure colonies, the performance of the Xpert Carba-R test with bacteria other than *Enterobacteriaceae*, *Pseudomonas aeruginosa*, or *Acinetobacter baumannii* has not been evaluated. Organisms should be identified, and carbapenem non-susceptibility status should be determined, prior to testing on Xpert Carba-R test.
- Erroneous test results might occur from improper culture techniques, failure to follow the recommended procedure to prepare the 0.5 McFarland suspension, handling and storage procedures, technical error, sample mix-up, or because the number of organisms in the specimen is too low to be detected by the test. Careful compliance with the instructions in this insert is necessary to avoid erroneous results.

## Expected Values

In the Xpert Carba-R Test clinical study, a total of 2543 specimens, consisting of rectal and perirectal swab specimens, and contrived specimens were evaluated across 8 study sites within and outside of the United States. Xpert Carba-R Test results in comparison to culture and bi-directional DNA sequence analysis by gene target for each of the prospective combined and contrived specimens is presented in [Table 2](#).

In a separate Xpert Carba-R Test clinical study, a total of 467 bacterial isolates were evaluated across 4 study sites within and outside of the United States. Xpert Carba-R Test results in comparison to bi-directional DNA sequence analysis by gene target for each of the two agar types are presented in [Table 8](#), [Table 9](#), [Table 10](#), [Table 11](#), and [Table 12](#).

# ! Specific Performance Characteristics

## Clinical Performance – Rectal and Perirectal Swab Specimens

Performance characteristics of the Xpert Carba-R Test with rectal and perirectal swab specimens were determined in a multi-site investigational study. The positive percent agreement (PPA) and negative percent agreement (NPA) of the Xpert Carba-R Test was evaluated relative to a reference method of culture (MacConkey enrichment broth) and PCR/bi-directional DNA sequence analysis.

Eight geographically diverse sites (six across the United States and two in Europe) prospectively collected paired rectal or perirectal swab specimens from subjects who were hospitalized or in a long-term care facility. Highly soiled rectal and perirectal swab specimens, according to the directions in [Specimen Collection, Transport and Storage](#) (Sample Preparation and Storage) were excluded from the study. Due to low prevalence of each of the Xpert Carba-R Test target genes in the absence of an outbreak, contrived specimens were also included in the study.

One swab of the pair was used for Xpert Carba-R testing. The second swab was inoculated into MacConkey enrichment broth and used for reference method testing. A reference culture laboratory determined the presence of carbapenem non-susceptible organisms by culturing the MacConkey enrichment broth from each of the specimens. The MacConkey enrichment broth was screened for the presence of carbapenem-non-susceptible organisms initially by plating the broth on MacConkey agar plates with a meropenem disk. For specimens that exhibited growth of gram-negative bacteria around the meropenem disk, confirmation of carbapenem non-susceptibility was determined on isolated colonies by using the disk diffusion method (per CLSI document M02) as well as CLSI document M100<sup>20</sup>. DNA extracted from the carbapenem non-susceptible isolates was purified, quantified, and amplified using primers specific to all five target genes; amplified regions included more bases than the regions amplified by the Xpert Carba-R Test. The production of the appropriate size amplification product was confirmed on Agilent 2100 Bioanalyzer (Agilent Technologies, Santa Clara, CA).

If bands shown on the Bioanalyzer corresponded to the expected size of the amplicon from any of the five target genes detected by the Xpert Carba-R Test, the amplicon for the isolate was sent to an independent laboratory for reference bi-directional sequencing analysis, which was validated for detection of the five targets in the Xpert Carba-R Test. If no bands were shown on the Bioanalyzer for any of the five target genes, the isolate was not sent for sequence analysis and the reference method result was considered negative for the five target genes.

### **Prospective Specimen Results Obtained with the Xpert Carba-R Test in Comparison to the Reference Method**

A total of 802 prospective rectal swab specimens were initially enrolled in this clinical study, of which 785



were eligible for inclusion. From the 785 eligible specimens, 755 specimens were included in the final dataset after exclusions based on protocol deviations (including 16 *Stenotrophomonas maltophilia* organisms that were excluded due to their intrinsic resistance to the carbapenems tested).

A total of 963 prospective perirectal swab specimens were initially enrolled in this clinical study, of which 947 were eligible for inclusion. From the 947 eligible specimens, 924 specimens were included in the final dataset after exclusions based on protocol deviations (including 10 *Stenotrophomonas maltophilia*, one *Pseudomonas putida* and one *Pseudomonas stutzeri* organisms that were excluded due to study design criteria).

When tested with prospective rectal swab specimens, the Xpert Carba-R Test demonstrated a PPA range from 60.0% to 100% for the four test targets (*bla*<sub>KPC</sub>, *bla*<sub>NDM</sub>, *bla*<sub>VIM</sub>, and *bla*<sub>OXA-48</sub>) relative to the reference method (Table 2). The NPA for the *bla*<sub>KPC</sub>, *bla*<sub>NDM</sub>, *bla*<sub>VIM</sub>, *bla*<sub>OXA-48</sub>, and *bla*<sub>IMP</sub> gene sequences ranged from 98.6% - 99.9% relative to the reference method (Table 2).

When tested with prospective perirectal swab specimens, the Xpert Carba-R Test demonstrated a PPA of 100% for the three test targets (*bla*<sub>NDM</sub>, *bla*<sub>KPC</sub> and *bla*<sub>OXA-48</sub>) relative to the reference method. The NPA for the *bla*<sub>KPC</sub>, *bla*<sub>NDM</sub>, *bla*<sub>VIM</sub>, *bla*<sub>OXA-48</sub>, and *bla*<sub>IMP</sub> gene sequences ranged from 99.6% to 100% relative to the reference method (Table 2).

With the prospective rectal and perirectal swab specimens combined, the Xpert Carba-R Test demonstrated a PPA range from 60.0% to 100% for the four test targets (*bla*<sub>KPC</sub>, *bla*<sub>NDM</sub>, *bla*<sub>VIM</sub>, and *bla*<sub>OXA-48</sub>) relative to the reference method (Table 2). The NPA for the *bla*<sub>KPC</sub>, *bla*<sub>NDM</sub>, *bla*<sub>VIM</sub>, *bla*<sub>OXA-48</sub>, and *bla*<sub>IMP</sub> gene sequences ranged from 99.3% - 99.9% relative to the reference method (Table 2).

For specimens with discordant results (the Xpert Carba-R Test was positive for a target gene but a carbapenem-non-susceptible organism was not isolated by reference culture), discordant analysis was performed using bi-directional sequencing on DNA extracted directly from the MacConkey enrichment broth. Discrepant testing results are footnoted in Table 2.

**Table 2. Xpert Carba-R Performance vs. Reference Culture + Sequencing – Prospective Specimens**

Specimen Type	Target	N	TP	FP	TN	FN	PPA (95% CI)	NPA (95% CI)
Rectal <sup>a</sup>	IMP	755	0	1 <sup>b</sup>	754	0	N/A	99.9% (99.3-100)
	VIM	755	6	8 <sup>c</sup>	737	4	60.0% (31.3-83.2)	98.9% (97.9-99.5)
	NDM	755	7	3 <sup>d</sup>	745	0	100% (64.6-100)	99.6% (98.8-99.9)
	KPC	755	29	6 <sup>ef</sup>	720	0	100% (88.3-100)	99.2% (98.2-99.6)
	OXA-48	755	29	10 <sup>g</sup>	715	1	96.7% (83.3-99.4)	98.6% (97.5-99.2)
Perirectal <sup>h</sup>	IMP	924	0	0	924	0	N/A	100% (99.6-100)
	VIM	924	0	0	924	0	N/A	100% (99.6-100)
	NDM	924	1	0	923	0	100% (20.7-100)	100% (99.6-100)
	KPC	924	2	4 <sup>i</sup>	918	0	100% (34.2-100)	99.6% (98.9-99.8)





Specimen Type	Target	N	TP	FP	TN	FN	PPA (95% CI)	NPA (95% CI)
	OXA-48	924	1	1 <sup>j</sup>	922	0	100% (20.7-100)	99.9% (99.4-100)
Combined <sup>i, j</sup>	IMP	1679	0	1 <sup>j</sup>	1678	0	N/A	99.9% (99.7-100)
	VIM	1679	6	8 <sup>j</sup>	1661	4	60.0% (31.3-83.2)	99.5% (99.1-99.8)
	NDM	1679	8	3 <sup>j</sup>	1668	0	100% (67.6-100)	99.8% (99.5-99.9)
	KPC	1679	31	10 <sup>k</sup>	1638	0	100% (89.0-100)	99.4% (98.9-99.7)
	OXA-48	1679	30	11 <sup>l</sup>	1637	1	96.8% (83.8-99.4)	99.3% (98.8-99.6)

N = Number, TP = True Positive, FP = False Positive, TN = True Negative, FN = False Negative

- Of the 755 prospective rectal swab specimens evaluated in the study, 636 specimens did not yield a culture isolate. From the remaining 119 specimens, 112 carbapenem-non-susceptible organisms were recovered by the Reference Culture in addition to 7 carbapenem susceptible organisms [*Pseudomonas aeruginosa* (5); *Escherichia coli* (1), and *Enterobacter cloacae* (1)].
- Testing results by sequencing: 1 of 1 was IMP negative.
- Testing results by sequencing: 2 of 8 were VIM positive; 6 of 8 were VIM negative.
- Testing results by sequencing: 1 of 3 was NDM positive; 2 of 3 were NDM negative.
- Testing results by sequencing: 1 of 6 was KPC positive; 5 of 6 were KPC negative.
- Site reported that subject was on ertapenem during time of specimen collection.
- Testing results by sequencing: 3 of 10 were OXA-48 positive; 7 of 10 were OXA-48 negative.
- Of the 924 prospective perirectal swab specimens evaluated in the study, 891 specimens did not yield a culture isolate. From the remaining 33 specimens, 31 carbapenem-non-susceptible organisms were recovered by the Reference Culture in addition to two carbapenem susceptible organisms (*Pseudomonas aeruginosa*).
- Testing results by sequencing: 4 of 4 were KPC negative.
- Testing results by sequencing: 1 of 1 was OXA-48 negative.
- Testing results by sequencing: 1 of 10 was KPC positive; 9 of 10 were KPC negative.
- Testing results by sequencing: 3 of 11 were OXA-48 positive; 8 of 11 were OXA-48 negative.

Performance of the Xpert Carba-R Test on the prospective rectal and perirectal specimens combined is shown in [Table 3](#) by species. Only organisms for which at least one positive specimen was collected are included in [Table 3](#).

**Table 3. Xpert Carba-R Performance vs. Reference Culture + Sequencing by Organism Type – Prospective Rectal and Perirectal Specimens**

Species <sup>a</sup>	Target	N	TP	FP	TN	FN	PPA (95% CI)	NPA (95% CI)
<i>Enterobacter aerogenes</i>	IMP	1	0	0	1	0	NA	100% (20.7-100)
	VIM	1	0	0	1	0	NA	100% (20.7-100)
	NDM	1	0	0	1	0	NA	100% (20.7-100)
	KPC	1	1	0	0	0	100% (20.7-100)	NA



Species <sup>a</sup>	Target	N	TP	FP	TN	FN	PPA (95% CI)	NPA (95% CI)
	OXA-48	1	0	0	1	0	NA	100% (20.7-100)
<i>Enterobacter cloacae</i>	IMP	4	0	0	4	0	NA	100% (51.0-100)
	VIM	4	1	0	3	0	100% (20.7-100)	100% (43.9-100)
	NDM	4	0	0	4	0	NA	100% (51.0-100)
	KPC	4	0	0	4	0	NA	100% (51.0-100)
	OXA-48	4	1	0	3	0	100% (20.7-100)	100% (43.9-100)
<i>Escherichia coli</i>	IMP	10	0	0	10	0	NA	100% (72.3-100)
	VIM	10	0	0	10	0	NA	100% (72.3-100)
	NDM	10	3	0	7	0	100% (43.9-100)	100% (67.6-100)
	KPC	10	2	0	8	0	100% (34.2-100)	100% (64.6-100)
	OXA-48	10	3	0	7	0	100% (43.9-100)	100% (64.6-100)
<i>Klebsiella oxytoca</i>	IMP	1	0	0	1	0	NA	100% (20.7-100)
	VIM	1	0	0	1	0	NA	100% (20.7-100)
	NDM	1	0	0	1	0	NA	100% (20.7-100)
	KPC	1	0	0	1	0	NA	100% (20.7-100)
	OXA-48	1	1	0	0	0	100% (20.7-100)	NA
<i>Klebsiella pneumoniae</i>	IMP	63	0	1	62	0	NA	98.4% (91.5-99.7)
	VIM	63	0	1	62	0	NA	98.4% (91.5-99.7)
	NDM	63	5	1	57	0	100% (56.6-100)	98.3% (90.9-99.7)
	KPC	63	28	1	34	0	100% (87.9-100)	97.1% (85.5-99.5)
	OXA-48	63	25	3	34	1	96.2% (81.1-99.3)	91.9% (78.7-97.2)
<i>Pseudomonas aeruginosa</i>	IMP	58	0	0	58	0	NA	100% (93.8-100)
	VIM	58	5	0	49	4	55.6% (26.7-81.1)	100% (92.7-100)
	NDM	58	0	1	57	0	NA	98.3% (90.9-99.7)
	KPC	58	0	2	56	0	NA	96.6% (88.3-99.1)
	OXA-48	58	0	0	58	0	NA	100% (93.8-100)

a. *Acinetobacter baumannii* (14) and *Enterobacter amnigenus* (1) were recovered but did not contain target sequences by the Reference Method or by the Xpert Carba-R Test.



Multiple targets were detected by the Xpert Carba-R Test in nine prospective specimens. The details are provided in [Table 4](#), along with the discrepant sequencing result.

**Table 4. Prospective Rectal and Perirectal Specimens with Multiple Targets Detected**

Specimen	Targets Detected by Xpert Carba-R Test	Targets Detected by Reference Sequencing	Discrepant Testing Results - Targets Detected by Reference Sequencing
1	KPC, OXA-48	NEG	NEG
2	VIM, KPC	NEG <sup>a</sup>	NEG <sup>a</sup>
3	VIM, OXA-48	OXA-48	OXA-48
4	KPC, OXA-48	KPC	KPC, OXA-48
5	NDM, OXA-48	NDM	NDM, OXA-48
6	VIM, NDM	NEG <sup>a</sup>	NEG
7	NDM, KPC	KPC	NDM, KPC
8	VIM, KPC	VIM	VIM, KPC
9	NDM, OXA-48	NDM, OXA-48	NA

a. An organism was not isolated from reference culture, therefore, reference sequencing was not performed.

#### Contrived Specimen Results Obtained with the Xpert Carba-R Test in Comparison to the Reference Method

A total of 864 contrived specimens (432 prepared in rectal swab matrix and 432 in perirectal matrix) were also tested as part of the clinical study.

In addition to *Enterobacteriaceae*, *Pseudomonas aeruginosa*, and *Acinetobacter baumannii* groups tested in the contrived study, 5 other non-*Enterobacteriaceae* strains were also evaluated: *Pseudomonas stutzeri* (1), *Pseudomonas oryzihabitans* (1), *Pseudomonas putida* (2), and *Empedobacter brevis* (1).

When tested with contrived specimens, the Xpert Carba-R Test demonstrated a range of PPA from 95% to 100% across the test targets (*blaKPC*, *blaNDM*, *blaVIM*, *blaOXA-48*, and *blaIMP*). The NPA for the *blaKPC*, *blaNDM*, *blaVIM*, *blaOXA-48*, and *blaIMP* gene sequences was 100% relative to the reference method ([Table 5](#)).

**Table 5. Xpert Carba-R Performance vs. Reference Method – Contrived Specimens**

Matrix	Target	N	TP	FP	TN	FN	PPA (95% CI)	NPA (95% CI)
Rectal	IMP	432	76	0	352	4	95.0% (87.8-98.0)	100% (98.9-100)
	VIM	432	81	0	350	1	98.8% (93.4-99.8)	100% (98.9-100)
	NDM	432	80	0	352	0	100% (95.4-100)	100% (98.9-100)
	KPC	432	80	0	352	0	100% (95.4-100)	100% (98.9-100)
	OXA-48	432	79	0	352	1	98.8% (93.3-99.8)	100% (98.9-100)
Perirectal	IMP	432	80	0	352	0	100% (95.4-100)	100% (98.9-100)
	VIM	432	82	0	350	0	100% (95.5-100)	100% (98.9-100)
	NDM	432	80	0	352	0	100% (95.4-100)	100% (98.9-100)
	KPC	432	80	0	352	0	100% (95.4-100)	100% (98.9-100)
	OXA-48	432	80	0	352	0	100% (95.4-100)	100% (98.9-100)
Combined	IMP	864	156	0	704	4	97.5% (93.7-99.0)	100% (99.5-100)



Matrix	Target	N	TP	FP	TN	FN	PPA (95% CI)	NPA (95% CI)
	VIM	864	163	0	700	1	99.4% (96.6-99.9)	100% (99.5-100)
	NDM	864	160	0	704	0	100% (97.7-100)	100% (99.5-100)
	KPC	864	160	0	704	0	100% (97.7-100)	100% (99.5-100)
	OXA-48	864	159	0	704	1	99.4% (96.5-99.9)	100% (99.5-100)

### Perirectal Swab and Rectal Swab Equivalence Study

To demonstrate equivalence of perirectal swab specimens and rectal swab specimens, a study was conducted at one site enrolling fresh prospectively collected rectal and perirectal swab specimens from consented subjects who were hospitalized in-patients.

Paired swab sets provided in the Cepheid Specimen Collection Device were used to collect specimens from each subject. One paired swab set was used to collect the perirectal swab specimen and a second paired swab set was used to collect the rectal swab specimen. The perirectal swab specimen was collected first followed by the rectal swab specimen from the same subject. One swab from each paired swab set was used for Xpert Carba-R Test testing. The second swab from each paired swab set was used for culture and susceptibility testing when either or both the perirectal or rectal swab specimen(s) were positive for one or more target(s) by the Xpert Carba-R Test. No culture was performed if perirectal and rectal swab specimens were both negative by the Xpert test.

Bi-directional DNA sequencing was performed on DNA extracted from isolated colonies that manifested carbapenem-non-susceptibility by the CLSI disk diffusion method or from MacConkey broth with meropenem disk if the culture result was negative and the Xpert Carba-R Test result was positive. Reference Method results were not used to change performance data for the swab equivalency study.

A total of 207 specimens were initially enrolled in this clinical study, all of which were eligible for inclusion. Of the 207 eligible specimens, 201 specimens were included in the final dataset used for the analyses. Six swab specimens (4 perirectal swab specimens and 2 rectal swab specimens) were excluded due to indeterminate results from the Xpert Carba-R Test.

Of the 201 specimens included in the data analyses, 92 (45.8%) were collected from female subjects and 109 (54.2%) from male subjects. Overall 45.8% (92/201) specimens were collected from subjects between 21 and 65 years of age and 54.2% (109/201) were from subjects >65 years of age.

The performance (PPA and NPA) of the Xpert Carba-R Test using perirectal swab specimens was determined relative to the results of the Xpert Carba-R Test using rectal swab specimens from the same subject. The PPA and NPA estimates are shown in Table 6. Relative to the Xpert Carba-R Test rectal swab specimen result, the perirectal swab specimens demonstrated an overall PPA and NPA of 94.7% (95%CI: 75.4-99.1) and 97.8% (95%CI: 94.5-99.1), respectively.

**Table 6. Xpert Carba-R Test – Perirectal Swab Specimens vs Rectal Swab Specimens**

	Xpert Carba-R Test – Rectal Swab Specimens			
		Pos	Neg	Total
Xpert Carba-R Test – Perirectal Swab Specimens	Pos	18 <sup>a</sup>	4 <sup>b</sup>	22
	Neg	1 <sup>c</sup>	178	179
	Total	19	182	201
		PPA	94.7% (95% CI: 75.4-99.1)	
		NPA	97.8% (95% CI: 94.5-99.1)	

- For one specimen, Xpert testing on the rectal swab was positive for KPC and OXA-48 and on the perirectal swab was positive for OXA-48 only. The specimen was culture negative for both rectal and perirectal swabs. Sequence results from the MacConkey broths were negative for the perirectal swab and OXA-48 positive for the rectal swab.
- 2 of 4 were culture positive for both rectal and perirectal swabs, sequence results from isolates were both OXA-48 positive, 1 of 4 was culture negative for both rectal and perirectal swabs, sequence result the rectal sequence result was not available due to isolate not saved; the perirectal isolate was interpreted as carbapenem susceptible and per protocol sequencing was not required.
- Culture negative for both rectal and perirectal swabs, sequence results from MacConkey broths were both OXA-48 Positive.

## Clinical Performance – Bacterial Isolates

Performance characteristics of the Xpert Carba-R Test with bacterial isolates were determined in a multi-site investigational study by comparing the Xpert Carba-R Test to reference bi-directional sequencing of the amplified DNA target. Study samples included bacterial isolates grown from both blood agar and MacConkey agar.

To be included in the study, isolates must have been previously identified as *Enterobacteriaceae*, *Pseudomonas aeruginosa*, or *Acinetobacter baumannii*. For determination of sensitivity, isolates must have been either intermediate or resistant to meropenem, ertapenem and/or imipenem per CLSI M100-S24<sup>22</sup>. Isolates of *Pseudomonas aeruginosa* or *Acinetobacter baumannii* must have been intermediate or resistant to either imipenem or meropenem. These organisms are intrinsically resistant to ertapenem. For evaluation of specificity, isolates may have been susceptible or resistant to meropenem, ertapenem, and imipenem per CLSI M100-S24<sup>22</sup>. *Pseudomonas aeruginosa* and *Acinetobacter baumannii* isolates should have been susceptible to both imipenem and meropenem. Isolates were tested only once in the study.

A total of 489 bacterial isolates (431 clinical stock isolates and 58 fresh isolates) were initially enrolled in this clinical study, of which 485 were eligible for inclusion. The ineligible isolates included four isolates previously enrolled in the study.

From the 485 eligible isolates, 467 isolates (410 clinical stock isolates and 57 fresh isolates) were included in the final dataset used for the analyses presented in this report; two isolates were excluded because reference testing was not performed; and sixteen isolates were excluded because they were not identified as *Enterobacteriaceae*, *A. baumannii*, or *P. aeruginosa*.

For Xpert Carba-R testing, well-isolated colonies that grew on each of the agar types were diluted to a 0.5 McFarland standard equivalent suspension using the direct colony suspension method per CLSI M07-A9.<sup>23</sup>

For reference sequencing, DNA from culture isolates was purified, quantified, and amplified using primers specific to all 5 target genes that were designed to amplify larger regions from the test targets than the primers included in the Xpert Carba-R Test. The production of the appropriate size of amplification product was confirmed on Agilent 2100 Bioanalyzer (Agilent Technologies, Santa Clara, CA).

If bands shown on the Bioanalyzer corresponded to the expected size of the amplicon from any of the five target genes detected by the Xpert Carba-R Test, the amplicon for the isolate was sent to an independent laboratory for reference bi-directional sequencing analysis, which was validated for detection of the five targets in the Xpert Carba-R Test. If no bands were shown on the Bioanalyzer for any of the five target genes,



the isolate was not sent for sequence analysis and the reference method result was considered negative for the five target genes.

Multiple targets were detected by the Xpert Carba-R Test in samples from ten isolates. The details are provided in [Table 7](#), along with the reference sequencing result.

**Table 7. Isolates with Multiple Targets Detected**

Isolate	Agar Type <sup>a</sup>	Targets Detected by Xpert Carba-R Test	Targets Detected by Reference Sequencing
1	BA, MC	NDM, OXA-48	NDM, OXA-48
2	BA	VIM, KPC	VIM
3	BA, MC	NDM, OXA-48	NDM, OXA-48
4	BA, MC	NDM, OXA-48	NDM, OXA-48
5	BA, MC	NDM, OXA-48	NDM, OXA-48
6	BA, MC	NDM, OXA-48	NDM, OXA-48
7	BA, MC	NDM, OXA-48	NDM, OXA-48
8	BA, MC	NDM, OXA-48	NDM, OXA-48
9	BA, MC	NDM, OXA-48	NDM, OXA-48
10	BA, MC	NDM, OXA-48	NDM, OXA-48

a. BA = blood agar; MC = MacConkey agar

When tested with isolates from blood agar, the Xpert Carba-R Test demonstrated an overall sensitivity and specificity of 100.0% (95% CI: 99.0-100) and 98.1% (95% CI: 93.2-99.5), respectively, relative to reference sequencing performed from the blood agar isolates ([Table 8](#)). The combined result was defined as positive for the Xpert Carba-R Test if any of the targets were positive, and negative for the Xpert Carba-R Test if all of the targets were negative.

**Table 8. Xpert Carba-R (blood agar) vs. Reference Sequencing (Isolate Grown on Blood Agar) — Combined**

Target	N	TP	FP	TN	FN	Sensitivity(95% CI)	Specificity (95% CI)
Combined	467	364 <sup>a</sup>	2 <sup>a</sup>	101	0	100% (99.0-100)	98.1% (93.2-99.5)

a. Combined results represent results by isolate. Multiple target results were observed for some isolates.

When tested with isolates from blood agar, the Xpert Carba-R Test demonstrated a sensitivity and specificity of >99% for each of the five test targets, relative to reference sequencing performed from the blood agar isolates ([Table 9](#)).

For isolates with discordant results between the Xpert Carba-R Test and reference sequencing, discrepant testing was performed using bi-directional sequencing on isolates from MacConkey agar plates. Discrepant testing results are footnoted in [Table 9](#) and [Table 11](#).

**Table 9. Xpert Carba-R (blood agar) vs. Reference Sequencing (Isolate Grown on Blood Agar) — By Target**

Target	N	TP	FP	TN	FN	Sensitivity (95% CI)	Specificity (95% CI)
IMP	467	40	1 <sup>a</sup>	426	0	100% (91.2-100)	99.8% (98.7-100)
VIM	467	82	1 <sup>b</sup>	384	0	100% (95.5-100)	99.7% (98.5-100)
NDM	467	78	0	389	0	100% (95.3-100)	100% (99.0-100)



Target	N	TP	FP	TN	FN	Sensitivity (95% CI)	Specificity (95% CI)
KPC	467	84	1 <sup>c</sup>	382	0	100% (95.6-100)	99.7% (98.5-100)
OXA-48	467	89	0	378	0	100% (95.9-100)	100% (99.0-100)

- The bi-directional DNA sequencing result for this false positive IMP isolate exhibited 92.95% sequence homology which was slightly below the 95% cutoff criteria. Discrepant testing was not performed.
- Discrepant testing results: 1 of 1 was VIM positive.
- This false positive isolate is likely due to KPC cross-contamination at the level of sample preparation. Discrepant testing did not produce a sequence match with the KPC target. Discrepant testing produced a sequence match for the VIM target, therefore this isolate is classified as a TP in the “Combined” assessment presented in [Table 8](#), above.

When tested with isolates from MacConkey agar, the Xpert Carba-R Test demonstrated an overall sensitivity and specificity of 100% (95% CI: 99.0-100) and 97.1% (95% CI: 91.8-99.0), respectively, relative to reference sequencing performed from the blood agar isolates ([Table 10](#)). The combined result was defined as positive for the Xpert Carba-R Test if any of the targets were positive, and negative for the Xpert Carba-R Test if all of the targets were negative.

**Table 10. Xpert Carba-R (MacConkey agar) vs. Reference Sequencing (Isolate Grown on Blood Agar— Combined)**

Target	N	TP	FP	TN	FN	Sensitivity (95% CI)	Specificity (95% CI)
Combined	467	364 <sup>a</sup>	3	100	0	100% (99.0-100)	97.1% (91.8-99.0)

- Combined results represent results by isolate. Multiple target results were observed for some isolates.

When tested with isolates from MacConkey agar, the Xpert Carba-R Test demonstrated a sensitivity and specificity of >99% for each of the five test targets, relative to reference sequencing performed from the blood agar isolates ([Table 11](#)).

**Table 11. Xpert Carba-R (MacConkey agar) vs. Reference Sequencing (Isolate Grown on Blood Agar) — By Target**

Target	N	TP	FP	TN	FN	Sensitivity (95% CI)	Specificity (95% CI)
IMP	467	40	1 <sup>a</sup>	426	0	100% (91.2-100)	99.8% (98.7-100)
VIM	467	82	1 <sup>b</sup>	384	0	100% (95.5-100)	99.7% (98.5-100)
NDM	467	78	1 <sup>c</sup>	388	0	100% (95.3-100)	99.7% (98.6-100)
KPC	467	84	0	383	0	100% (95.6-100)	100% (99.0-100)
OXA-48	467	89	0	378	0	100% (95.9-100)	100% (99.0-100)

- The bi-directional DNA sequencing result for this false positive IMP isolate exhibited 92.95% sequence homology which was slightly below the 95% cutoff criteria. Discrepant testing was not performed.
- Discrepant testing results: 1 of 1 was VIM positive.
- The clinical site reported that in-house characterization of this false positive isolate prior to study testing resulted in a positive NDM gene target. Discrepant testing did not produce a sequence match for any of the 5 gene targets.

The Xpert Carba-R Test performance by specific organism group is shown in [Table 12](#) for both blood agar and MacConkey Agar medium. The overall result was defined as positive for the Xpert Carba-R Test if any of the targets were positive, and negative for the Xpert Carba-R Test if all of the targets were negative.



**Table 12. Xpert Carba-R vs. Reference Sequencing**

Medium	Organisms	Target	N	TP	FP	TN	FN	Sensitivity (95% CI)	Specificity (95% CI)
Blood Agar	<i>Enterobacteriaceae</i>	IMP	343	4	0	339	0	100% (51.0-100)	100% (98.9-100)
		VIM	343	51	1	291	0	100% (93.0-100)	99.7% (98.1-99.9)
		NDM	343	73	0	270	0	100% (95.0-100)	100% (98.6-100)
		KPC	343	83	1	259	0	100% (95.6-100)	99.6% (97.9-99.9)
		OXA-48	343	89	0	254	0	100% (95.9-100)	100% (98.5-100)
		Overall	343	291 <sup>a</sup>	1 <sup>a</sup>	51	0	100% (98.7-100)	98.1% (89.9-99.7)
	<i>Pseudomonas aeruginosa</i>	IMP	80	16	1	63	0	100% (80.6-100)	98.4% (91.7-99.7)
		VIM	80	31	0	49	0	100% (89.0-100)	100% (92.7-100)
		NDM	80	0	0	80	0	NA	100% (95.4-100)
		KPC	80	1	0	79	0	100% (20.7-100)	100% (95.4-100)
		OXA-48	80	0	0	80	0	NA	100% (95.4-100)
		Overall	80	48	1	31	0	100% (92.6-100)	96.9% (84.3-99.5)
	<i>Acinetobacter baumannii</i>	IMP	44	20	0	24	0	100% (83.9-100)	100% (86.2-100)
		VIM	44	0	0	44	0	NA	100% (92.0-100)
		NDM	44	5	0	39	0	100% (56.6-100)	100% (91.0-100)
		KPC	44	0	0	44	0	NA	100% (92.0-100)
		OXA-48	44	0	0	44	0	NA	100% (92.0-100)
		Overall	44	25	0	19	0	100% (86.7-100)	100% (83.2-100)
MacConkey Agar	<i>Enterobacteriaceae</i>	IMP	343	4	0	339	0	100% (51.0-100)	100% (98.9-100)
		VIM	343	51	1	291	0	100% (93.0-100)	99.7% (98.1-99.9)
		NDM	343	73	1	269	0	100% (95.0-100)	99.6% (97.9-99.9)
		KPC	343	83	0	260	0	100% (95.6-100)	100% (98.5-100)
		OXA-48	343	89	0	254	0	100% (95.9-100)	100% (98.5-100)
		Overall	343	291 <sup>a</sup>	2	50	0	100% (98.7-100)	96.2% (87.0-98.9)
	<i>Pseudomonas aeruginosa</i>	IMP	80	16	1	63	0	100% (80.6-100)	98.4% (91.7-99.7)
		VIM	80	31	0	49	0	100% (89.0-100)	100% (92.7-100)
		NDM	80	0	0	80	0	NA	100% (95.4-100)
		KPC	80	1	0	79	0	100% (20.7-100)	100% (95.4-100)
		OXA-48	80	0	0	80	0	NA	100% (95.4-100)
		Overall	80	48	1	31	0	100% (92.6-100)	96.9% (84.3-99.5)
	<i>Acinetobacter baumannii</i>	IMP	44	20	0	24	0	100% (83.9-100)	100% (86.2-100)
		VIM	44	0	0	44	0	NA	100% (92.0-100)
		NDM	44	5	0	39	0	100% (56.6-100)	100% (91.0-100)
		KPC	44	0	0	44	0	NA	100% (92.0-100)
		OXA-48	44	0	0	44	0	NA	100% (92.0-100)
		Overall	44	25	0	19	0	100% (86.7-100)	100% (83.2-100)

a. Overall results represent results by isolate. Multiple target results were observed for some isolates.

Xpert Carba-R Test results by phenotype are presented in [Table 13](#) and [Table 14](#) below. Phenotypic results





were based on the organism identification and susceptibility results for each of the isolates. The combined result was defined as positive for the Xpert Carba-R Test if any of the five test targets were positive, and negative for the Xpert Carba-R Test if all five of the test targets were negative. A non-susceptible phenotype means the isolate was intermediate or resistant to at least one carbapenem. A susceptible phenotype means the isolate was susceptible to imipenem, meropenem, and ertapenem.

**Table 13. Xpert Carba-R (blood agar) vs. Phenotype — Combined**

Phenotypic Results				
		Non-susceptible	Susceptible	Total
Xpert Carba-R	<b>Gene Detected</b>	356	10	366
	<b>Gene Not Detected</b>	95	6	101
	<b>Total</b>	451	16	467

**Table 14. Xpert Carba-R (MacConkey agar) vs. Phenotype — Combined**

Xpert Carba-R (MacConkey agar) vs. Phenotype — Combined				
		Non-susceptible	Susceptible	Total
Xpert Carba-R	<b>Gene Detected</b>	357	10 <sup>a</sup>	367
	<b>Gene Not Detected</b>	94 <sup>b</sup>	6	100
	<b>Total</b>	451	16	467

- The 10 isolates that are phenotypically carbapenem susceptible but positive by the Xpert Carba-R Test may contain mutations that inactivate or down regulate expression of the carbapenem resistance gene detected by the Xpert Carba-R Test.
- The 94 isolates that are phenotypically carbapenem non-susceptible but negative by the Xpert Carba-R Test may contain other mechanisms of carbapenem resistance, such as AmpC beta-lactamases or extended spectrum beta-lactamases in combination with porin mutations, or potentially other carbapenem resistance genes that are not detected by the Xpert Carba-R Test.

Among the 934 tests performed (467 isolates x 2 agar types), one had an initial **NO RESULT** outcome (0.10%, 95% CI 0.00-0.58). The isolate yielded valid results upon repeat test. The overall valid reporting rate of the test was 100% (934/934).

## Analytical Performance

### Analytical Sensitivity (Limit of Detection) – Rectal and Perirectal Swabs

The analytical sensitivity or Limit of Detection (LoD) of the Xpert Carba-R test was assessed using carbapenemase-producing organisms seeded into pooled negative human rectal swab matrix and pooled negative human perirectal swab matrix. The LoD was determined for two carbapenemase-producing bacteria for each gene analyte, i.e., the genes encoding KPC, NDM, VIM, OXA-48, and IMP. Bacteria were titered by plate counts and spiked onto clean swabs. Swabs were placed into pooled negative rectal swab matrix or pooled negative perirectal swab matrix and replicates of 20 were evaluated at a minimum of five different concentrations over four days. The LoD for each of the ten carbapenemase-producing organisms was estimated by probit analysis. The LoD is defined as the lowest concentration of target cells (CFU/swab) that can be reproducibly distinguished from negative samples with 95% confidence. The study was performed with two different lots of Xpert Carba-R reagents and the claimed LoD is the higher of the two determinations. The estimated LoDs were verified by preparing and testing 10 replicates from two independent dilutions of each bacterium at each estimated LoD.

The claimed LoD for each pair of carbapenemase-producing organism in rectal swab and perirectal swab



matrices are shown in [Table 15](#) and [Table 16](#).

**Table 15. LoD Estimates and Verification for Organisms Harboring Carbapenemase Genes using the Xpert Carba-R Test in Rectal Swab Matrix**

Target Gene and Organism	LoD Estimates (Probit) CFU/Swab		LoD Claim CFU/Swab	Estimated LoD in Sample Reagent (CFU/mL)	Verification (Positives/20)
	Lot 1	Lot 2			
IMP-1 <i>Acinetobacter baumannii</i>	174	141	174	35	20/20
IMP-1 <i>Klebsiella pneumoniae</i>	303	306	306	61	20/20
VIM-1 <i>Klebsiella pneumoniae</i>	247	305	305	61	20/20
VIM-4 <i>Escherichia coli</i>	815	468	815	163	20/20
NDM-1 <i>Klebsiella pneumoniae</i> ATCC BAA-2146	117	251	251	50	20/20
NDM <i>Klebsiella pneumoniae</i>	74	57	74	15	19/20
KPC-3 <i>Klebsiella pneumoniae</i> NCTC 13438	373	292	373	75	20/20
KPC <i>Enterobacter cloacae</i>	779	537	779	156	20/20
OXA-48 <i>Enterobacter cloacae</i>	154	109	154	31	20/20
OXA-48 <i>Escherichia coli</i>	104	99	104	21	20/20

**Table 16. LoD Estimates and Verification for Organisms Harboring Carbapenemase Genes using the Xpert Carba-R Test in Perirectal Swab Matrix**

Target Gene and Organism	LoD Estimates (Probit) CFU/Swab		LoD Claim CFU/Swab	Estimated LoD in Sample Reagent (CFU/mL)	Verification (Positives/20)
	Lot 1	Lot 2			
IMP-1 <i>Acinetobacter baumannii</i>	90	118	118	24	19/20
IMP-1 <i>Klebsiella pneumoniae</i>	269	635	635	127	20/20
VIM-1 <i>Klebsiella pneumoniae</i>	901	514	901	180	20/20
VIM-4 <i>Escherichia coli</i>	446	403	446	89	20/20
NDM-1 <i>Klebsiella pneumoniae</i> ATCC BAA-2146	133	113	133	27	20/20
NDM <i>Klebsiella pneumoniae</i>	56	54	56	11	20/20
KPC-3 <i>Klebsiella pneumoniae</i> NCTC 13438	358	292	358	72	20/20
KPC <i>Enterobacter cloacae</i>	1259	1303	1303	261	20/20
OXA-48 <i>Enterobacter cloacae</i>	223	166	223	45	20/20
OXA-48 <i>Escherichia coli</i>	126	137	137	27	20/20

## Rectal and Perirectal Swab Matrices Study

The analytical reactivity of the Xpert Carba-R test with rectal swab and perirectal swab matrices were evaluated by testing a panel of 72 samples. This panel consisted of 11 *bla*<sub>KPC</sub> (KPC), 11 *bla*<sub>VIM</sub> (VIM), 8 *bla*<sub>OXA-48</sub> (OXA-48), 5 *bla*<sub>NDM</sub>/*bla*<sub>OXA-181</sub> (NDM/OXA-181), 6 *bla*<sub>OXA-181</sub> (OXA-181), 17 *bla*<sub>IMP</sub> (IMP), and one *bla*<sub>KPC</sub>/*bla*<sub>VIM</sub> (KPC/VIM) well-characterized bacterial strains. The strains tested in rectal swab and



perirectal swab matrices and their test concentrations are presented in [Table 17](#).

For testing in rectal swab and perirectal swab matrices, organisms were seeded into pooled negative rectal swab matrix or pooled negative perirectal swab matrix. All bacterial strains were tested in triplicate for both swab matrices. Xpert Carba-R target genes were detected in 69 of 72 carbapenemase-producing bacterial strains although IMP-4 was detected only using a higher concentration ([Table 17](#)). Xpert Carba-R target DNA sequences were not detected in three bacterial strains as shown in [Table 17](#). In one of the three bacterial strains, the IMP-13 gene was not detected by the test, although it was predicted to be detected by *in silico* analysis. In two of the other three bacterial strains, the IMP-7 and IMP-14 genes were not predicted to be detected by *in silico* analysis and were not detected by the test. See in the instructions for use.

**Table 17. Analytical Reactivity of the Xpert Carba-R Test in Rectal Swab and Perirectal Swab Matrices**

Strain ID	Organism	Resistance Marker with Variant Information	Concentration Tested in Rectal Swab and Perirectal Swab Matrices (CFU/mL)
NCTC 13438	<i>Klebsiella pneumoniae</i>	KPC-3	153
31551	<i>Klebsiella pneumoniae</i>	KPC-4	50
ATCC BAA-1705	<i>Klebsiella pneumoniae</i>	KPC-2	130
PA-Col	<i>Pseudomonas aeruginosa</i>	KPC-2	250
KBM18	<i>Enterobacter aerogenes</i>	KPC-2	250
BM9	<i>Klebsiella pneumoniae</i>	KPC-3	330
PA3	<i>Klebsiella pneumoniae</i>	KPC-2	100
CGNC	<i>Serratia marcescens</i>	KPC-2	300
CFVL	<i>Enterobacter cloacae</i>	KPC-2	160
COL	<i>Escherichia coli</i>	KPC-2	147
GR-04/KP-69	<i>Klebsiella pneumoniae</i>	KPC-2, VIM	80
164-3	<i>Klebsiella oxytoca</i>	KPC	70
NCTC 13437	<i>Pseudomonas aeruginosa</i>	VIM-10	500
NCTC 13439	<i>Klebsiella pneumoniae</i>	VIM-1	130
NCTC 13440	<i>Klebsiella pneumoniae</i>	VIM-1	70
758	<i>Pseudomonas aeruginosa</i>	VIM	250
PA-87	<i>Klebsiella pneumoniae</i>	VIM	200
B92A	<i>Pseudomonas aeruginosa</i>	VIM	2000
Col1	<i>Pseudomonas aeruginosa</i>	VIM-2	500



Strain ID	Organism	Resistance Marker with Variant Information	Concentration Tested in Rectal Swab and Perirectal Swab Matrices (CFU/mL)
BM19	<i>Serratia marcescens</i>	VIM-2	250
KOW7	<i>Escherichia coli</i>	VIM-4	250
DIH	<i>Klebsiella pneumoniae</i>	VIM-19	250
MSH2014-3	<i>Enterobacter cloacae</i>	VIM	500
NCTC 13443	<i>Klebsiella pneumoniae</i>	NDM-1	80
ATCC BAA-2146	<i>Klebsiella pneumoniae</i>	NDM-1	80
34262	<i>Klebsiella pneumoniae</i>	NDM	80
GEN	<i>Acinetobacter baumannii</i>	NDM-1	130
3047	<i>Enterobacter cloacae</i>	NDM-1	70
7892	<i>Proteus mirabilis</i>	NDM-1	30
CAN	<i>Salmonella spp.</i>	NDM-1	70
EGY	<i>Acinetobacter baumannii</i>	NDM-2	40
I5	<i>Escherichia coli</i>	NDM-4	30
405	<i>Escherichia coli</i>	NDM-5	30
CF-ABE	<i>Citrobacter freundii</i>	NDM	30
73999	<i>Pseudomonas aeruginosa</i>	NDM	50
39365	<i>Providencia rettgeri</i>	NDM-1	70
NCTC 13442	<i>Klebsiella pneumoniae</i>	OXA-48	40
OM11	<i>Klebsiella pneumoniae</i>	OXA-48	60
501	<i>Enterobacter cloacae</i>	OXA-48	80
DUW	<i>Klebsiella pneumoniae</i>	OXA-48	120
OM22	<i>Escherichia coli</i>	OXA-48	80
BOU	<i>Enterobacter cloacae</i>	OXA-48	80
TUR	<i>Enterobacter cloacae</i>	OXA-48	120
11670	<i>Escherichia coli</i>	OXA-48	100
166643	<i>Klebsiella pneumoniae</i>	OXA-181	20
42194	<i>Klebsiella pneumoniae</i>	OXA-181	20



Strain ID	Organism	Resistance Marker with Variant Information	Concentration Tested in Rectal Swab and Perirectal Swab Matrices (CFU/mL)
MSH2014-64	<i>Klebsiella pneumoniae</i>	OXA-181	280
MSH2014-72	<i>Escherichia coli</i>	OXA-181	100
74	<i>Escherichia coli</i>	OXA-181	100
CDC0051	<i>Klebsiella ozaenae</i> <sup>a</sup>	OXA-181	250
B108A	<i>Klebsiella pneumoniae</i>	NDM, OXA-181	10
C10192-DISCS	<i>Enterobacter aerogenes</i>	NDM, OXA-181	10
KP-OMA3	<i>Klebsiella pneumoniae</i>	NDM, OXA-181	60
1300920	<i>Klebsiella pneumoniae</i>	NDM, OXA-181	15
MSH2014-69	<i>Klebsiella pneumoniae</i>	NDM, OXA-181	20
NCTC 13476	<i>Escherichia coli</i>	IMP-1	250
695	<i>Acinetobacter baumannii</i>	IMP-1	1720
2340	<i>Enterobacter cloacae</i>	IMP-1	250
IMPBMI	<i>Klebsiella pneumoniae</i>	IMP-1	100
Yonsei_1	<i>Acinetobacter baumannii</i>	IMP-1	1000
Yonsei_2	<i>Acinetobacter baumannii</i>	IMP-1	500
6852	<i>Klebsiella pneumoniae</i>	IMP-1	100
MKAM	<i>Pseudomonas aeruginosa</i>	IMP-1	500
70450-1	<i>Pseudomonas aeruginosa</i>	IMP-1	250
3994	<i>Pseudomonas spp.</i>	IMP-10	250
CDC0161	<i>Enterobacter aerogenes</i> <sup>a</sup>	IMP-4	5.00E+04
5344	<i>Pseudomonas aeruginosa</i>	IMP-2	60
3985	<i>Pseudomonas aeruginosa</i>	IMP-11	2000
4032	<i>Pseudomonas aeruginosa</i>	IMP-6	80
3424	<i>Pseudomonas aeruginosa</i>	IMP-7 <sup>b,c</sup>	1.00E+06



Strain ID	Organism	Resistance Marker with Variant Information	Concentration Tested in Rectal Swab and Perirectal Swab Matrices (CFU/mL)
32443	<i>Klebsiella pneumoniae</i>	IMP-13 <sup>c</sup>	1.00E+06
92	<i>Pseudomonas aeruginosa</i>	IMP-14 <sup>c, c</sup>	1.00E+06

- These organisms were not tested as bacterial isolates.
- IMP-7 and IMP-14 genes (*Pseudomonas aeruginosa*) were not detected by the test and were not predicted to be detected by *in silico* analysis (see ).
- IMP-13 gene (*Klebsiella pneumoniae*): although predicted to be detected by *in silico* analysis, the IMP-13 gene was not detected by the test (see ).

## Bacterial Isolate Study

The analytical sensitivity of the Xpert Carba-R test with bacterial isolates was also evaluated by testing a panel of 71 samples consisting of 11 *bla*<sub>KPC</sub> (KPC), 13 *bla*<sub>NDM</sub> (NDM), 11 *bla*<sub>VIM</sub> (VIM), 8 *bla*<sub>OXA-48</sub> (OXA-48), 5 *bla*<sub>NDM/bla</sub><sub>OXA-181</sub> (NDM/OXA-181), 5 *bla*<sub>OXA-181</sub> (OXA-181), 17 *bla*<sub>IMP</sub> (IMP), and one *bla*<sub>KPC/bla</sub><sub>VIM</sub> (KPC/VIM) well-characterized bacterial strains. The strains tested as bacterial isolates are presented in [Table 18](#).

For bacterial isolate testing, organisms were tested in replicates of four that were prepared by diluting 10 µL of 0.5 McFarland cell suspension for each bacterial strain in 5 mL of Sample Reagent. Testing was performed using both blood agar and MacConkey plates. Xpert Carba-R target genes were detected in 68 of 71 bacterial strains from both plates. Xpert Carba-R target DNA sequences were not detected in three bacterial strains as shown in the footnote to [Table 18](#). In one of the three bacterial strains, the IMP-13 gene was not detected by the test, although it was predicted to be detected by *in silico* analysis. In two of the three bacterial strains, the IMP-7 and IMP-14 genes that were not detected by the test were also not predicted to be detected by *in silico* analysis. See the section in the instructions for use.

**Table 18. Analytical Reactivity of the Xpert Carba-R Test – Bacterial Isolates**

Strain ID	Organism	Resistance Marker with Variant Information
NCTC 13438	<i>Klebsiella pneumoniae</i>	KPC-3
31551	<i>Klebsiella pneumoniae</i>	KPC-4
ATCC BAA-1705	<i>Klebsiella pneumoniae</i>	KPC-2
PA-Col	<i>Pseudomonas aeruginosa</i>	KPC-2
KBM18	<i>Enterobacter aerogenes</i>	KPC-2
BM9	<i>Klebsiella pneumoniae</i>	KPC-3
PA3	<i>Klebsiella pneumoniae</i>	KPC-2
CGNC	<i>Serratia marcescens</i>	KPC-2
CFVL	<i>Enterobacter cloacae</i>	KPC-2
COL	<i>Escherichia coli</i>	KPC-2
GR-04/KP-69	<i>Klebsiella pneumoniae</i>	KPC-2, VIM
164-3	<i>Klebsiella oxytoca</i>	KPC
NCTC 13437	<i>Pseudomonas aeruginosa</i>	VIM-10
NCTC 13439	<i>Klebsiella pneumoniae</i>	VIM-1
NCTC 13440	<i>Klebsiella pneumoniae</i>	VIM-1



Strain ID	Organism	Resistance Marker with Variant Information
758	<i>Pseudomonas aeruginosa</i>	VIM
PA-87	<i>Klebsiella pneumoniae</i>	VIM
B92A	<i>Pseudomonas aeruginosa</i>	VIM
Col1	<i>Pseudomonas aeruginosa</i>	VIM-2
BM19	<i>Serratia marcescens</i>	VIM-2
KOW7	<i>Escherichia coli</i>	VIM-4
DIH	<i>Klebsiella pneumoniae</i>	VIM-19
MSH2014-3	<i>Enterobacter cloacae</i>	VIM
NCTC 13443	<i>Klebsiella pneumoniae</i>	NDM-1
ATCC BAA-2146	<i>Klebsiella pneumoniae</i>	NDM-1
34262	<i>Klebsiella pneumoniae</i>	NDM
GEN	<i>Acinetobacter baumannii</i>	NDM-1
3047	<i>Enterobacter cloacae</i>	NDM-1
7892	<i>Proteus mirabilis</i>	NDM-1
CAN	<i>Salmonella spp.</i>	NDM-1
EGY	<i>Acinetobacter baumannii</i>	NDM-2
I5	<i>Escherichia coli</i>	NDM-4
405	<i>Escherichia coli</i>	NDM-5
CF-ABE	<i>Citrobacter freundii</i>	NDM
73999	<i>Pseudomonas aeruginosa</i>	NDM
39365	<i>Providencia rettgeri</i>	NDM-1
NCTC 13442	<i>Klebsiella pneumoniae</i>	OXA-48
OM11	<i>Klebsiella pneumoniae</i>	OXA-48
501	<i>Enterobacter cloacae</i>	OXA-48
DUW	<i>Klebsiella pneumoniae</i>	OXA-48
OM22	<i>Escherichia coli</i>	OXA-48
BOU	<i>Enterobacter cloacae</i>	OXA-48
TUR	<i>Enterobacter cloacae</i>	OXA-48
11670	<i>Escherichia coli</i>	OXA-48
MSH2014-64	<i>Klebsiella pneumoniae</i>	OXA-181
MSH2014-72	<i>Escherichia coli</i>	OXA-181
B108A	<i>Klebsiella pneumoniae</i>	NDM, OXA-181
C10192-DISCS	<i>Enterobacter aerogenes</i>	NDM, OXA-181
KP-OMA3	<i>Klebsiella pneumoniae</i>	NDM-1, OXA-181
166643	<i>Klebsiella pneumoniae</i>	OXA-181
42194	<i>Klebsiella pneumoniae</i>	OXA-181
1300920	<i>Klebsiella pneumoniae</i>	NDM, OXA-181
MSH2014-69	<i>Klebsiella pneumoniae</i>	NDM, OXA-181
74	<i>Escherichia coli</i>	OXA-181
NCTC 13476	<i>Escherichia coli</i>	IMP-1



Strain ID	Organism	Resistance Marker with Variant Information
695	<i>Acinetobacter baumannii</i>	IMP-1
2340	<i>Enterobacter cloacae</i>	IMP-1
IMPBMI	<i>Klebsiella pneumoniae</i>	IMP-1
6852	<i>Klebsiella pneumoniae</i>	IMP-1
Yonsei_1	<i>Acinetobacter baumannii</i>	IMP-1
Yonsei_2	<i>Acinetobacter baumannii</i>	IMP-1
70450-1	<i>Pseudomonas aeruginosa</i>	IMP-1
3994	<i>Pseudomonas spp.</i>	IMP-10
MKAM	<i>Pseudomonas aeruginosa</i>	IMP-1
5344	<i>Pseudomonas aeruginosa</i>	IMP-2
G029	<i>Salmonella spp</i>	IMP-4
3985	<i>Pseudomonas aeruginosa</i>	IMP-11
4032	<i>Pseudomonas aeruginosa</i>	IMP-6
3424	<i>Pseudomonas aeruginosa</i>	IMP-7 <sup>a,b</sup>
32443	<i>Klebsiella pneumoniae</i>	IMP-13 <sup>b</sup>
92	<i>Pseudomonas aeruginosa</i>	IMP-14 <sup>b,.b</sup>

a. Not detected by Xpert Carba-R (see ).

b. IMP-7 and IMP-14 genes were not detected by the test and were not predicted to be detected by *in silico* analysis ().

The variants detected, and predictions for detecting other subtypes of each resistance gene based on *in silico* analysis, are presented in Table 19 (representing results from both the rectal swab matrix and bacterial isolate study).

**Table 19. Summary of Variants Detected by Wet Testing or Predicted to be Detected Based on *In Silico* Analysis**

Marker (or Traditional Subgroup)	Wet Testing			Not Tested but Predicted to be Detected Based on <i>in silico</i> Analysis
	No. of Samples	Type(s) Detected	Type(s) not Detected	
KPC	12	KPC-2, 3, 4	--	KPC-5, 6, 7, 8, 9, 10, 11, 12, 13, 14, 15, 16
NDM	18	NDM-1, 2, 4, 5	--	NDM-3, 6, 7, 8, 9
VIM	12	VIM-1, 2, 4, 10, 19	--	VIM-5, 6, 7, 8, 9, 11, 12, 13, 14, 15, 16, 17, 18, 20, 23, 24, 25, 26, 27, 28, 29, 30, 31, 32, 33, 34, 35, 36, 37, 38
OXA-48	18	OXA-48, 181 (OXA-48 variant)	--	OXA-162, 163, 204, 232, 244, 245, 247
IMP	17	IMP-1 (9 strains), IMP-2, 4, 6, 10, 11	IMP-7 <sup>a</sup> , 13 <sup>b</sup> , 14 <sup>b</sup>	IMP-3, 8, 9, 13 <sup>b</sup> , 19, 20, 21, 22, 24, 25, 27, 28, 30, 31, 33, 37, 40, 42

a. IMP-7 and IMP-14 genes (*Pseudomonas aeruginosa*) were not detected by the test and were not predicted to be detected by *in silico* analysis (see ).

b. IMP-13 gene (*Klebsiella pneumoniae*) was tested: although predicted to be detected by *in silico* analysis, the IMP-13 gene was not detected by the test (see ).





## Analytical Specificity (Cross-Reactivity)

The analytical specificity of the Xpert Carba-R test was evaluated for bacterial isolates, organisms seeded into rectal swab matrix, and organisms seeded into perirectal swab matrix. For all three specimen types, a panel of 62 well-characterized bacterial strains of carbapenem-susceptible bacteria or bacteria with carbapenem non-susceptibility due to genes or mechanisms other than the Xpert Carba-R target genes (Table 20 and Table 21) and 24 commensal bacterial strains and other enteric microorganisms were also evaluated in the study (Table 22). Human cells were also tested in rectal swab and perirectal swab matrices (see Table 23). Resistance mechanisms were determined by individual PCR tests, DNA sequence analysis, or Check-Points array version CT102.

For rectal swab matrix and perirectal swab matrix samples, 62 strains were tested at concentrations  $>1 \times 10^6$  CFU/mL with the exception of *Peptostreptococcus anaerobius* that was tested at  $5 \times 10^5$  CFU/mL. Viruses were tested at  $>1 \times 10^5$  TCID<sub>50</sub>/mL or greater than  $2.5 \times 10^7$  RNA copies/mL. A bladder cell line (human genomic DNA) was tested at  $1 \times 10^5$  cells/mL. Organisms were diluted into pooled negative rectal swab matrix or pooled negative perirectal swab matrix and tested in triplicate. None of the 94 potentially cross-reactive organisms and nucleic acids tested was detected with the Xpert Carba-R test.

For bacterial isolates, organisms were grown aerobically on blood agar and MacConkey agar plates. Two cell suspensions equivalent to a 0.5 McFarland cell suspension were prepared from isolated colonies on each type of agar plate. Each organism was tested a total of four times (two replicates from each of two 0.5 McFarland cell suspensions per organism) from each plate.

The Xpert Carba-R test did not cross react with any of the organisms tested (Table 20, Table 21, Table 22, and Table 23). The analytical specificity of the test was 100%.

**Table 20. Number of Carbapenem-Susceptible and Non-Susceptible Organisms for each Antibiotic**

	Ertapenem	Imipenem	Meropenem
<b>Susceptible</b>	19	30	24
<b>Intermediate</b>	0	8	4
<b>Resistant</b>	43	24	34

**Table 21. Cross-Reactivity Panel**

Organism	Strain ID	Confirmed Resistance Mechanisms	Carbapenem Susceptibility (S/I/R) <sup>a</sup>		
			ETP <sup>a</sup>	IMP <sup>a</sup>	MEM <sup>a</sup>
<i>Escherichia coli</i>	NCTC 13441	CTX-M (-1, -type 15 like); TEM	S	S	S
<i>Klebsiella pneumoniae</i>	NCTC 13465	CTX-M (25)	S	S	S
<i>Enterobacter aerogenes</i>	810	OmpC/OmpF deficient; TEM	R	R	R
<i>Citrobacter freundii</i>	1698	TEM (WT+164S)	S	S	S
<i>Enterobacter cloacae</i>	5557	AmpC (ACT/MIR)	R	R	R
<i>Klebsiella pneumoniae</i>	kpn5	CTX-M-2	R	S	R
<i>Klebsiella pneumoniae</i>	kpn12	TEM; SHV; CTX-M	R	R	R
<i>Escherichia coli</i>	eco1	TEM; CTX-M-2	R	R	R
<i>Escherichia coli</i>	eco2	CTX-M (2); TEM; OXA-2	R	S	S
<i>Enterobacter cloacae</i>	cor1	CTX-M (2); TEM	R	R	R



Organism	Strain ID	Confirmed Resistance Mechanisms	Carbapenem Susceptibility (S/I/R) <sup>a</sup>		
			ETP <sup>a</sup>	IMP <sup>a</sup>	MEM <sup>a</sup>
<i>Serratia marcescens</i>	hpp21	CTX-M (2); TEM	S	S	S
<i>Morganella morganii</i>	fer29	CTX-M (2); TEM	S	R	S
<i>Proteus mirabilis</i>	gut25	CTX-M (2); TEM	S	R	S
<i>Salmonella spp.</i>	3209	CTX-M (2); TEM	S	S	S
<i>Shigella flexnerii</i>	3331	CTX-M (2); TEM	S	S	S
<i>Enterobacter cloacae</i>	PA_3	AmpC; CTX-M-15; TEM	S	S	S
<i>Klebsiella pneumoniae</i>	32189	SHV	S	S	S
<i>Klebsiella pneumoniae</i>	32443	CTX-M (1, -type 15 like); SHV	S	S	S
<i>Klebsiella pneumoniae</i>	32598	CTX-M (-1, -type 15 like); SHV; TEM	R	I	R
<i>Klebsiella pneumoniae</i>	33560	CTX-M (15); SHV-11; TEM-1	S	S	S
<i>Klebsiella pneumoniae</i>	33603	SHV-2	R	I	R
<i>Klebsiella pneumoniae</i>	33617	SHV-27	S	S	S
<i>Klebsiella pneumoniae</i>	33643	SHV (-5, -55); TEM	S	S	S
<i>Klebsiella pneumoniae</i>	34430	SHV; TEM; CTX-M-15	S	S	S
<i>Klebsiella pneumoniae</i>	34680	TEM; CTX-M-2	R	S	R
<i>Klebsiella pneumoniae</i>	34732	CTX-M (15); SHV; TEM	R	S	S
<i>Enterobacter cloacae</i>	PA_174	GX-/Culture+; SHV; TEM	S	S	S
<i>Enterobacter aerogenes</i>	STU 645	SHV (WT+238S+240K)	R	S	R
<i>Enterobacter aerogenes</i>	STU 669	SHV (WT+238S+240K)	R	R	R
<i>Escherichia coli</i>	C3015	AmpC (CMY II); TEM	R	R	R
<i>Enterobacter aerogenes</i>	RI_100	AmpC (DHA); SHV	R	R	R
<i>Klebsiella pneumoniae</i>	B4A	SHV (WT + 238S + 240K)	R	R	R
<i>Klebsiella pneumoniae</i>	B13A	SHV (WT + 238S + 240K)	R	S	S
<i>Enterobacter cloacae</i>	RI_474	AmpC (ACT/MIR)	R	I	I
<i>Enterobacter amnigenus</i>	B71	AmpC (ACT/MIR)	R	R	R
<i>Klebsiella pneumoniae</i>	DD82A	SHV (WT + 238S + 240K)	R	S	R
<i>Klebsiella pneumoniae</i>	B100	CTX-M (-1, type-15 like); SHV (WT+238S); TEM	R	S	R
<i>Enterobacter cloacae</i>	135B	TEM	S	S	S
<i>Klebsiella pneumoniae</i>	B157	SHV; TEM	R	R	R
<i>Escherichia coli</i>	T2914280	CTX-M (-1, -15); TEM	R	S	R
<i>Providencia stuartii</i>	DD188	TEM (104K + 164S)	R	I	I
<i>Enterobacter cloacae</i>	DD189	AmpC (ACT/MIR)	R	S	S
<i>Escherichia coli</i>	B198B	CTX-M (-1, type -15 like); TEM	R	S	R
<i>Klebsiella pneumoniae</i>	T3019989-1	CTX-M (-1, type-15 like); SHV	R	I	R
<i>Klebsiella pneumoniae</i>	T3019989-2	CTX-M (-1, type-15 like); SHV	R	S	R
<i>Enterobacter cloacae</i>	ENC-THAI14	VEB-1, TEM	S	S	S
<i>Escherichia coli</i>	CB154006	CTX-M (9); TEM	R	I	I
<i>Enterobacter cloacae</i>	S35766	AmpC (ACT/MIR)	S	S	S
<i>Enterobacter cloacae</i>	X1856910	AmpC (ACT/MIR); TEM	R	I	I



Organism	Strain ID	Confirmed Resistance Mechanisms	Carbapenem Susceptibility (S/I/R) <sup>a</sup>		
			ETP <sup>a</sup>	IMP <sup>a</sup>	MEM <sup>a</sup>
<i>Klebsiella pneumoniae</i>	W3758164	CTX-M (-1, -15 like); SHV; TEM	R	I	R
<i>Klebsiella pneumoniae</i>	X2135758	CTX-M (-1, -15 like); SHV	R	S	S
<i>Klebsiella pneumoniae</i>	W3809535	CTX-M (-1, -15 like); SHV	R	R	R
<i>Pseudomonas aeruginosa</i>	CDC0064	SPM	R	R	R
<i>Serratia marcescens</i>	CDC0099	SME	R	R	R
<i>Serratia marcescens</i>	CDC0121	SME	R	R	R
<i>Serratia marcescens</i>	CDC0122	SME	R	R	R
<i>Serratia marcescens</i>	CDC0123	SME	R	R	R
<i>Serratia marcescens</i>	CDC0124	SME	R	R	R
<i>Serratia marcescens</i>	CDC0130	SME	R	R	R
<i>Serratia marcescens</i>	CDC0131	SME	R	R	R
<i>Enterobacter cloacae</i> group	CDC0132	IMI	R	R	R
<i>Enterobacter cloacae</i> complex	CDC0164	IMI	R	R	R

a. S/I/R = Susceptible/Intermediate/Resistant, ETP = Ertapenem, IMP = Imipenem, MEM = Meropenem

**Table 22. Cross-reactivity Panel (Commensal and Other Enteric Microorganisms)**

Strain ID	Organism	Concentration Tested (CFU/mL Unless Otherwise Specified)
ATCC 25922	<i>Escherichia coli</i>	2.67E+06
ATCC 29212	<i>Enterococcus faecalis</i>	3.15E+06
ATCC 700603	<i>Klebsiella pneumoniae</i>	5.20E+06
ATCC 35218	<i>Escherichia coli</i>	2.47E+06
ATCC 25923	<i>Staphylococcus aureus</i>	4.53E+06
ATCC 27853	<i>Pseudomonas aeruginosa</i>	3.17E+06
ATCC 9689	<i>Clostridium difficile</i> <sup>a</sup>	1.80E+07
ATCC 700621	<i>Enterobacter cloacae</i>	8.95E+06
ATCC 9756	<i>Enterococcus faecium</i>	6.54E+06
ATCC 13182	<i>Klebsiella oxytoca</i>	4.76E+06
ATCC BAA-747	<i>Acinetobacter baumannii</i>	2.27E+06
ATCC 33128	<i>Citrobacter freundii</i>	2.01E+06
ATCC 49948	<i>Morganella morganii</i>	8.19E+06
ATCC 51331	<i>Stenotrophomonas maltophilia</i>	3.15E+06
ATCC 27028	<i>Citrobacter koseri</i>	5.05E+06
ATCC 49809	<i>Providencia stuartii</i>	3.01E+06
ATCC 49037	<i>Peptostreptococcus anaerobius</i> <sup>a</sup>	5.00E+05
CCUG 29780 / ATCC 12401	<i>Streptococcus agalactiae</i>	5.21E+06
ATCC 15703	<i>Bifidobacterium adolescentis</i> <sup>a</sup>	1.10E+08
ATCC 51697	<i>Enterobacter aerogenes</i>	3.19E+06
ATCC 43071	<i>Proteus mirabilis</i>	1.78E+06



Strain ID	Organism	Concentration Tested (CFU/mL Unless Otherwise Specified)
CCUG 34787	<i>Acinetobacter spp.</i>	2.40E+06
CCUG 418	<i>Citrobacter freundii</i>	2.95E+06
CCUG 33629	<i>Corynebacterium diphtheriae</i>	4.48E+06
CCUG 17874	<i>Helicobacter pylori</i>	1.61E+06
CCUG 33548	<i>Listeria monocytogenes</i>	4.77E+06
CCUG 6325	<i>Providencia alcalifaciens</i>	4.91E+06
CCUG 43594 / ATCC 33560	<i>Campylobacter jejuni</i> <sup>a</sup>	3.27E+06
MRVP/ZeptoMetrix	<i>Adenovirus B Type 7A/NY</i> <sup>a</sup>	1.40E+05 TCID <sub>50</sub> /mL
MRVP/ZeptoMetrix	<i>Enterovirus Type 71/NY</i> <sup>a</sup>	4.40E+05 TCID <sub>50</sub> /mL
Clinical Sample – Cepheid	<i>Norovirus GI</i> <sup>a</sup>	2.5 x 10 <sup>7</sup> RNA copies/mL

a. These organisms were tested in rectal swab and perirectal swab matrix.

**Table 23. Cell Line Representing Human Genomic DNA**

Organism Name	Source
Bladder Cell Carcinoma (hgDNA)	ATCC HTB-4

## Competitive Interference

A competitive interference study was performed to test whether a high titer of one or more carbapenemase-producing organisms would interfere with the detection of a second target carbapenemase-producing organism that was present at a low titer. High titer samples were formulated at concentrations of  $5 \times 10^6$  CFU/swab and low titer targets were formulated at approximately 2xLoD for the respective strain in either rectal swab matrix or perirectal swab matrix. One carbapenemase-producing bacterial strain for each gene analyte, i.e., the genes encoding KPC, NDM, VIM, OXA-48, and IMP, was used in this study. Each carbapenemase-producing bacterial strain type was tested at low titers in conjunction with a high titer of each of the other one or two carbapenemase-producing bacterial strain types (Table 24). Samples were tested in replicates of eight.

An inhibitory effect was observed for three of the five targets (IMP, VIM, and OXA-48) when a low concentration of each target was present in combination with a high concentration of one or two other targets for samples tested in rectal swab matrix. The three targets (IMP, VIM, and OXA-48) were tested at a higher concentration (4x LoD) in combination with a high concentration of one or two other targets for samples in rectal swab matrix. No inhibitory effect was observed for the three targets (IMP, VIM and OXA-48) at 4x LoD in the presence of clinically relevant co-infections for the Xpert Carba-R Test.

An inhibitory effect was observed for two of the five targets (NDM and IMP) when a low concentration of each target was present in combination with a high concentration of one or two other targets for samples tested in perirectal swab matrix. The two targets (NDM and IMP) were tested at a higher concentration (4x LoD) in combination with a high concentration of one or two other targets for samples in perirectal swab matrix. No inhibitory effect was observed for the two targets (NDM and IMP) at 4x LoD in the presence of clinically relevant co-infections for the Xpert Carba-R test.

The competitive inhibitory effect on the Carba-R targets (NDM, IMP, VIM and OXA-48) is addressed in [Limitations](#) in the instructions for use.



**Table 24. Combinations of Carbapenemase-producing Bacteria Tested with the Xpert Carba-R Test**

Combination
High KPC/High NDM/Low VIM
High KPC/High NDM/Low OXA
High KPC/High NDM/Low IMP
High VIM/High OXA/Low KPC
High VIM/High OXA/Low NDM
High VIM/High OXA/Low IMP
High IMP/Low KPC
High IMP/Low NDM
High IMP/Low VIM
High IMP/Low OXA
High OXA/Low VIM
High VIM/Low OXA
High KPC/Low NDM
Negative

## Potentially Interfering Substances

The performance of the Xpert Carba-R test was evaluated with 24 potentially interfering substances that may be present in rectal swab and perirectal swab specimens. Potentially interfering substances (IS) solutions were prepared and tested at concentrations specified in [Table 25](#). Positive and negative samples were included in this study. Positive samples consisted of a mix of five carbapenemase-producing organisms harboring KPC, NDM, VIM, IMP-1 and OXA-48 gene sequences seeded into pooled negative rectal swab matrix or pooled negative perirectal swab matrix at approximately 3x LoD. Eight replicate positive samples were tested per substance. Negative samples consisted of pooled negative rectal swab matrix or pooled negative perirectal swab matrix not seeded with carbapenemase-producing organisms. Eight replicate negative samples were tested per substance to determine the effect on the performance of the sample processing control (SPC). Controls consisted of positive and negative samples with no interfering substances added. The effect of each potentially interfering substance on positive and negative replicates was evaluated by comparing target cycle threshold (Ct) values generated in the presence of the substance to Ct values from controls lacking the substance.

The positive and negative replicate samples for 22 potentially interfering substances were correctly identified using the Xpert Carba-R test. Interference with the Xpert Carba-R test may be observed with barium sulfate at > 0.1% w/v and Pepto-Bismol at > 0.01% w/v in tests with rectal swab matrix samples. See [Limitations](#) in the instructions for use. Rectal swab matrix samples, positive for a mix of five carbapenemase-producing organisms harboring KPC, NDM, VIM, IMP-1 and OXA-48 gene sequences that were tested with fecal fat at 0.25% w/v, did not yield any false negative results, however, delayed cycle threshold values were observed for the VIM target. This potential interference from the presence of 0.25% w/v fecal fat is provided in the [Limitations](#) of the instructions for use. Interference with the Xpert Carba-R test may be observed with barium sulfate at > 0.1% w/v and Pepto-Bismol at > 0.025% w/v in tests with perirectal swab matrix samples. See [Limitations](#).

**Table 25. Potentially Interfering Substances Tested**

Substance/Class	Active Ingredient	Concentration Tested
Non-steroidal anti-inflammatory medication	Naproxen	0.25% w/v
Imaging compound	Barium sulfate	0.25% and 0.1% w/v
Antibiotic (oral)	Cephalexin	0.25% w/v
Antibiotic (oral)	Ciprofloxacin	0.25% w/v
Condom with spermicidal lubricant	Nonoxynol-9	1 condom <sup>a</sup>
Creams/ointment/suppositories	Hydrocortisone	0.25% w/v
Laxative	Sennosides	0.25% w/v
Lipids	Stearic acid/Palmitic acid/Cholesterol (fecal fat)	0.25% w/v
Anti-diarrheal medication	Loperamide hydrochloride/bismuth subsalicylate (Imodium)	0.25% w/v
Anti-diarrheal medication	Loperamide hydrochloride/bismuth subsalicylate (Kaopectate)	0.25% w/v
Topical cream	K-Y Jelly	0.25% w/v
Antacids	Calcium carbonate/aluminum hydroxide/magnesium hydroxide/simethicone (Milk of Magnesia)	0.25% w/v
Enemas	Mineral oil	0.25% w/v
Antibiotic (topical)	Polymixin B/ Neomycin/ Bacitracin (Neosporin)	0.25% w/v
Anti-fungal/ anti-itch Vaginal	Nystatin	0.25% w/v
Antacid	Famotidine (Pepcid)	0.25% w/v
Anti-diarrheal medication	Loperamide hydrochloride/bismuth subsalicylate (Pepto-Bismol)	0.25%, 0.1%, 0.05%, 0.025%, 0.01% w/v
Topical cream	Petroleum jelly	0.25% w/v
Anti-hemorrhoid creams/ ointments	Phenylephrine (Preparation H)	0.25% w/v
Acid reducer; antacid	Omeprazole (Prilosec)	0.25% w/v
Enemas	Saline-enema	0.25% w/v
Antacid	Cimetidine (Tagamet)	0.25% w/v
Anti-fungal/anti-itch Vaginal	Benzocaine, resorcinol (Vagisil)	0.25% w/v
Moist towelettes	Benzalkonium chloride, ethanol (Wet Ones)	1 piece <sup>b</sup>

a. One condom added to 40 mL swab matrix.

b. One piece (5 inch x 7-1/2 inch) added to 40 mL swab matrix.

## Carry-over Contamination Study

A study was conducted to demonstrate that single-use, self-contained GeneXpert cartridges prevent carry-over contamination in negative samples run following very high positive samples. The study consisted of a negative sample processed in the same GeneXpert module immediately following a very high positive sample. The high positive sample is composed of inactivated *E. coli* cells containing a plasmid with an insert



consisting of a synthetic oligonucleotide of the amplicon sequences from the five Xpert Carba-R target analyte genes (KPC, NDM, VIM, IMP and OXA-48 targets). Positive cells were diluted in pooled negative rectal swab matrix and perirectal swab matrix to a concentration of  $1 \times 10^6$  CFU/mL. The testing scheme was repeated 25 times on two GeneXpert modules for a total of 102 tests (25 high positive samples per module and 26 negative samples per module) for the rectal swab matrix and perirectal swab matrix. All 50 positive samples correctly reported all Xpert Carba-R targets as **DETECTED**, and all 52 negative samples correctly reported all Xpert Carba-R targets as **NOT DETECTED** for each matrix type tested.

## Rectal and Perirectal Swab Matrix Study

Reproducibility of the Xpert Carba-R test was evaluated using two panels of 11 samples, one prepared in pooled negative rectal swab matrix and one prepared in pooled negative perirectal swab matrix. Two operators at each of the three study sites tested one panel of 11 samples in replicates of four per day over six testing days (11 samples x 2 replicates x 2 times/day x 6 days x 2 operators x 3 sites). Three lots of Xpert Carba-R cartridges were used at each of the 3 testing sites. The Xpert Carba-R test was performed according to the Xpert Carba-R test procedure. Results are summarized in [Table 26](#).

**Table 26. Summary of Reproducibility Results - % Agreement, Rectal and Perirectal Swab Matrices**

Sample	Matrix <sup>a</sup>	Site 1			Site 2			Site 3			% Total Agreement by Sample
		Op 1	Op 2	Site	Op 1	Op 2	Site	Op 1	Op 2	Site	
<b>Neg</b>	R	100% (24/24)	100% (24/24)	100% (48/48)	100% (24/24)	100% (24/24)	100% (48/48)	100% (24/24)	100% (24/24)	100% (48/48)	100% (144/144)
<b>IMP Mod Pos</b>	R	100% (24/24)	100% (24/24)	100% (48/48)	100% (24/24)	100% (24/24)	100% (48/48)	100% (24/24)	100% (24/24)	100% (48/48)	100% (144/144)
<b>IMP Low Pos</b>	R	91.7% (22/24)	87.5% (21/24)	89.5% (43/48)	83.3% (20/24)	87.5% (21/24)	85.4% (41/48)	87.5% (21/24)	79.2% (19/24)	83.3% (40/48)	86.1% (124/144)
<b>VIM Mod Pos</b>	R	100% (24/24)	100% (24/24)	100% (48/48)	100% (24/24)	100% (24/24)	100% (48/48)	100% (24/24)	100% (24/24)	100% (48/48)	100% (144/144)
<b>VIM Low Pos</b>	R	100% (24/24)	100% (24/24)	100% (48/48)	100% (24/24)	100% (24/24)	100% (48/48)	100% (24/24)	100% (24/24)	100% (48/48)	100% (144/144)
<b>NDM Mod Pos</b>	R	100% (24/24)	100% (24/24)	100% (48/48)	100% (24/24)	100% (24/24)	100% (48/48)	100% (24/24)	100% (24/24)	100% (48/48)	100% (144/144)
<b>NDM Low Pos</b>	R	91.7% (22/24)	95.8% (23/24)	93.8% (45/48)	95.8% (23/24)	95.8% (23/24)	95.8% (46/48)	100% (24/24)	91.7% (22/24)	95.8% (46/48)	95.1% (137/144)
<b>KPC Mod Pos</b>	R	100% (24/24)	100% (24/24)	100% (48/48)	100% (24/24)	100% (24/24)	100% (48/48)	100% (24/24)	100% (24/24)	100% (48/48)	100% (144/144)
<b>KPC Low Pos</b>	R	95.8% (23/24)	100% (24/24)	97.9% (47/48)	100% (24/24)	91.7% (22/24)	95.8% (46/48)	95.8% (23/24)	95.8% (23/24)	95.8% (46/48)	96.5% (139/144)
<b>OXA-48 Mod Pos</b>	R	100% (24/24)	100% (24/24)	100% (48/48)	100% (24/24)	100% (24/24)	100% (48/48)	100% (24/24)	100% (24/24)	100% (48/48)	100% (144/144)
<b>OXA-48 Low Pos</b>	R	95.8% (23/24)	100% (24/24)	97.9% (47/48)	95.8% (23/24)	100% (24/24)	97.9% (47/48)	91.7% (22/24)	100% (24/24)	95.8% (46/48)	97.2% (140/144)
<b>Neg</b>	PR	100% (24/24)	100% (24/24)	100% (48/48)	100% (24/24)	100% (24/24)	100% (48/48)	100% (24/24)	100% (24/24)	100% (48/48)	100% (144/144)
<b>IMP Mod Pos</b>	PR	100% (24/24)	100% (24/24)	100% (48/48)	100% (24/24)	100% (24/24)	100% (48/48)	100% (24/24)	100% (24/24)	100% (48/48)	100% (144/144)
<b>IMP Low Pos</b>	PR	95.8% (23/24)	91.7% (22/24)	93.8% (45/48)	100% (24/24)	100% (24/24)	100% (48/48)	100% (24/24)	91.7% (22/24)	95.8% (46/48)	96.5% (139/144)



Sample	Matrix <sup>a</sup>	Site 1			Site 2			Site 3			% Total Agreement by Sample
		Op 1	Op 2	Site	Op 1	Op 2	Site	Op 1	Op 2	Site	
VIM Mod Pos	PR	100% (24/24)	100% (24/24)	100% (48/48)	100% (24/24)	100% (24/24)	100% (48/48)	100% (24/24)	100% (24/24)	100% (48/48)	100% (144/144)
VIM Low Pos	PR	100% (24/24)	91.7% (22/24)	95.8% (46/48)	91.7% (22/24)	91.7% (22/24)	91.7% (44/48)	95.8% (23/24)	83.3% (20/24)	89.6% (43/48)	92.4% (133/144)
NDM Mod Pos	PR	100% (24/24)	100% (24/24)	100% (48/48)	100% (24/24)	100% (24/24)	100% (48/48)	100% (24/24)	100% (24/24)	100% (48/48)	100% (144/144)
NDM Low Pos	PR	100% (24/24)	100% (24/24)	100% (48/48)	100% (24/24)	100% (24/24)	100% (48/48)	87.5% (21/24)	100% (24/24)	93.8% (45/48)	97.9% (141/144)
KPC Mod Pos	PR	100% (24/24)	100% (24/24)	100% (48/48)	100% (24/24)	100% (24/24)	100% (48/48)	100% (24/24)	100% (24/24)	100% (48/48)	100% (144/144)
KPC Low Pos	PR	91.7% (22/24)	91.7% (22/24)	91.7% (44/48)	91.7% (22/24)	95.8% (23/24)	93.8% (45/48)	100% (24/24)	91.7% (22/24)	95.8% (46/48)	93.8% (135/144)
OXA-48 Mod Pos	PR	100% (24/24)	100% (24/24)	100% (48/48)	100% (24/24)	100% (24/24)	100% (48/48)	100% (24/24)	100% (24/24)	100% (48/48)	100% (144/144)
OXA-48 Low Pos	PR	87.5% (21/24)	87.5% (21/24)	87.5% (42/48)	100% (24/24)	95.8% (23/24)	97.9% (47/48)	95.8% (23/24)	95.8% (23/24)	95.8% (46/48)	93.8% (135/144)

a. R=rectal, PR=perirectal

The reproducibility of the Xpert Carba-R test was also evaluated in terms of the fluorescence signal expressed in Ct values for each target detected. The mean, standard deviation (SD), and coefficient of variation (CV) between-sites, between-lots, between-days, between-operators, and within-tests for each panel member are presented in [Table 27](#).

**Table 27. Summary of Reproducibility Data, Rectal and Perirectal Swab Matrices**

Sample	Matrix <sup>a</sup>	Test Channel (Analyte)	N <sup>b</sup>	Mean Ct	Between-Site		Between-Lot		Between-Day		Between-Operator		Within-Test		Total	
					SD	CV (%)	SD	CV (%)	SD	CV (%)	SD	CV (%)	SD	CV (%)	SD	CV (%)
Neg	R	SPC	144	32.9	0.2	0.5	0.2	0.7	0.0	0.1	0.0	0	0.6	1.8	0.7	2.0
IMP Mod Pos	R	IMP	144	34.5	0.0	0.0	0.2	0.5	0	0.0	0.1	0.2	0.7	2.0	0.7	2.1
IMP Low Pos	R	IMP	140	36.4	0.0	0.0	0.0	0.0	0.2	0.5	0.0	0	1.2	3.3	1.2	3.4
VIM Mod Pos	R	VIM	144	31.0	0.0	0.0	0.3	0.9	0	0.0	0.2	0.5	0.5	1.6	0.6	1.9
VIM Low Pos	R	VIM	144	33.8	0.0	0.0	0.6	1.8	0.3	0.9	0.3	1.0	1.4	4.0	1.6	4.6
NDM Mod Pos	R	NDM	144	33.7	0.0	0.0	0.0	0.0	0.0	0.1	0.0	0.0	0.6	1.7	0.6	1.7
NDM Low Pos	R	NDM	143	36.2	0.2	0.7	0.0	0.0	0.3	0.7	0.0	0.0	0.8	2.3	0.9	2.5
KPC Mod Pos	R	KPC	144	34.2	0.0	0.0	0.3	0.8	0.2	0.6	0.0	0.0	0.4	1.2	0.6	1.6
KPC Low Pos	R	KPC	141	35.8	0.0	0.0	0.5	1.5	0.0	0.0	0.3	0.9	0.7	1.9	0.9	2.6
OXA-48 Mod Pos	R	OXA-48	144	34.3	0.0	0.0	0.2	0.5	0.2	0.5	0.1	0.3	0.5	1.6	0.6	1.7





Sample	Matrix <sup>a</sup>	Test Channel (Analyte)	N <sup>b</sup>	Mean Ct	Between-Site		Between-Lot		Between-Day		Between-Operator		Within-Test		Total	
					SD	CV (%)	SD	CV (%)	SD	CV (%)	SD	CV (%)	SD	CV (%)	SD	CV (%)
OXA-48 Low Pos	R	OXA-48	143	36.1	0.0	0.0	0.0	0.0	0.2	0.6	0.0	0.0	0.8	2.3	0.9	2.4
Neg	PR	SPC	144	32.7	0.0	0.0	0.2	0.6	0.0	0.0	0.2	0.5	0.4	1.2	0.5	1.4
IMP Mod Pos	PR	IMP	144	33.7	0.0	0.0	0.1	0.2	0.0	0.0	0.2	0.5	0.5	1.5	0.5	1.6
IMP Low Pos	PR	IMP	142	36.0	0.2	0.5	0.0	0.0	0.1	0.3	0.2	0.5	0.8	2.1	0.8	2.3
VIM Mod Pos	PR	VIM	144	31.2	0.1	0.2	0.1	0.3	0.0	0.1	0.2	0.5	0.4	1.3	0.5	1.5
VIM Low Pos	PR	VIM	142	35.0	0.0	0.0	0.6	1.6	0.0	0.0	0.6	1.7	1.4	4.1	1.6	4.7
NDM Mod Pos	PR	NDM	144	33.2	0.0	0.0	0.0	0.0	0.2	0.5	0.2	0.5	0.4	1.2	0.5	1.4
NDM Low Pos	PR	NDM	143	35.7	0.2	0.5	0.0	0.0	0.2	0.6	0.0	0.0	0.9	2.4	0.9	2.5
KPC Mod Pos	PR	KPC	144	34.6	0.0	0.0	0.3	1.0	0.0	0.0	0.2	0.5	0.4	1.3	0.6	1.7
KPC Low Pos	PR	KPC	143	36.4	0.0	0.0	0.5	1.3	0.1	0.4	0.0	0.0	0.7	2.0	0.9	2.4
OXA-48 Mod Pos	PR	OXA-48	144	34.4	0.1	0.2	0.2	0.6	0.0	0.0	0.2	0.5	0.5	1.5	0.6	1.7
OXA-48 Low Pos	PR	OXA-48	144	36.4	0.0	0.0	0.0	0.0	0.4	1.2	0.0	0.0	1.0	2.7	1.1	2.9

a. R=rectal, PR=perirectal

b. Results with non-zero Ct values out of 144.

## Bacterial Isolate Study

Reproducibility of the Xpert Carba-R test was evaluated using a panel of 13 bacterial samples that included: two different organisms per each of the five resistance gene targets detected by the Xpert Carba-R test; two stock samples that included two gene targets; and one stock sample negative for all five gene targets. Two operators at each of the three study sites tested one panel of 13 samples in replicates of four per day. Each sample was used to make two 0.5 McFarland equivalent suspensions from which two replicates were tested over six testing days (13 samples x 2 replicates x 2 times/day x 6 days x 2 operators x 3 sites). Three lots of Xpert Carba-R cartridges were used at each of the 3 testing sites. The Xpert Carba-R test was performed according to the Xpert Carba-R test procedure. Upon completion of the testing, 25 tests run on one instrument module were excluded resulting in a total of 1847 samples included in the analyses. Results are summarized in [Table 28](#).



**Table 28. Summary of Reproducibility Results – % Agreement, Bacterial Isolates**

Resistance Gene (Sample #)	Site 1			Site 2			Site 3			% Total Agreement by Sample
	Op 1	Op 2	Site	Op 1	Op 2	Site	Op 1	Op 2	Site	
KPC (1)	100% (24/24)	100% (24/24)	100% (48/48)	100% (24/24)	100% (24/24)	100% (48/48)	100% (24/24)	100% (24/24)	100% (48/48)	100% (144/144)
KPC (2)	100% (23/23)	100% (22/22)	100% (45/45)	95.8% (23/24)	100% (24/24)	97.9% (47/48)	100% (24/24)	100% (24/24)	100% (48/48)	99.3% (140/141)
VIM (1)	100% (22/22)	100% (23/23)	100% (45/45)	100% (24/24)	100% (24/24)	100% (48/48)	100% (24/24)	100% (24/24)	100% (48/48)	100% (141/141)
VIM (2)	100% (22/22)	100% (24/24)	100% (46/46)	100% (24/24)	100% (24/24)	100% (48/48)	100% (24/24)	100% (24/24)	100% (48/48)	100% (142/142)
IMP (1)	100% (23/23)	100% (24/24)	100% (47/47)	100% (24/24)	100% (24/24)	100% (48/48)	100% (24/24)	100% (24/24)	100% (48/48)	100% (143/143)
IMP (2)	100% (23/23)	100% (23/23)	100% (46/46)	100% (24/24)	100% (24/24)	100% (48/48)	100% (24/24)	100% (24/24)	100% (48/48)	100% (142/142)
OXA (1)	100% (23/23)	100% (23/23)	100% (46/46)	100% (24/24)	91.7% (22/24)	95.8% (46/48)	100% (24/24)	100% (24/24)	100% (48/48)	98.6% (140/142)
OXA (2)	100% (23/23)	100% (22/22)	100% (45/45)	100% (24/24)	100% (24/24)	100% (48/48)	100% (24/24)	100% (24/24)	100% (48/48)	100% (141/141)
NDM (1)	100% (22/22)	100% (21/21)	100% (43/43)	100% (24/24)	100% (24/24)	100% (48/48)	100% (24/24)	100% (24/24)	100% (48/48)	100% (139/139)
NDM (2)	100% (23/23)	100% (23/23)	100% (46/46)	91.7% (22/24)	100% (24/24)	95.8% (46/48)	100% (24/24)	100% (24/24)	100% (48/48)	98.6% (140/142)
OXA,NDM (1)	100% (24/24)	100% (23/23)	100% (47/47)	100% (24/24)	100% (24/24)	100% (48/48)	100% (24/24)	100% (24/24)	100% (48/48)	100% (143/143)
OXA,NDM (2)	100% (23/23)	100% (24/24)	100% (47/47)	100% (24/24)	100% (24/24)	100% (48/48)	100% (24/24)	100% (24/24)	100% (48/48)	100% (143/143)
NEG	100% (24/24)	100% (24/24)	100% (48/48)	100% (24/24)	100% (24/24)	100% (48/48)	100% (24/24)	100% (24/24)	100% (48/48)	100% (144/144)

The reproducibility of the Xpert Carba-R test was also evaluated in terms of the fluorescence signal expressed in Ct values for each target detected. The mean, standard deviation (SD), and coefficient of variation (CV) between-sites, between-lots, between-days, between-operators, and within-tests for each panel member are presented in [Table 29](#).

**Table 29. Summary of Reproducibility Data – Bacterial Isolates**

Resistance Gene (Sample #)	Test Channel (Analyte)	N <sup>a</sup>	Between-Site		Between-Lot		Between-Day		Between-Operator		Within-Test		Total	
			SD	CV	SD	CV	SD	CV	SD	CV	SD	CV	SD	CV
KPC (1)	KPC	144	1.1	4.4	0	0	0	0	0.6	2.6	0.6	2.6	1.4	5.8
KPC (2)	KPC	143	0.8	3.1	0.1	0.2	0.2	0.9	0.5	2.0	0.8	3.1	1.2	4.9
VIM (1)	VIM	141	1.1	5.1	0	0	0	0	0.5	2.3	0.8	3.7	1.5	6.7
VIM (2)	VIM	142	0.3	1.3	0.2	0.8	0	0	0.8	3.8	0.7	3.1	1.1	5.1
IMP (1)	IMP	143	0.3	1.0	0	0	0.3	1.2	0.6	2.3	0.8	3.1	1.0	4.2
IMP (2)	IMP	142	1.4	6.3	0.1	0.5	0	0	0.6	2.8	0.7	3.2	1.7	7.6
OXA (1)	OXA48	140	0.6	2.6	0	0	0	0	0.7	2.8	0.8	3.5	1.2	5.2
OXA (2)	OXA48	141	1.1	4.9	0.3	1.5	0	0	0.5	2.0	0.7	3.3	1.5	6.4



Resistance Gene (Sample #)	Test Channel (Analyte)	N <sup>a</sup>	Between-Site		Between-Lot		Between-Day		Between-Operator		Within-Test		Total	
			SD	CV	SD	CV	SD	CV	SD	CV	SD	CV	SD	CV
NDM (1)	NDM	139	1.2	5.3	0	0	0	0	0.6	2.4	0.7	3.1	1.5	6.6
NDM (2)	NDM	140	0.9	4.0	0.3	1.4	0	0	0.8	3.3	0.8	3.3	1.5	6.3
NDM/OXA (1)	NDM	143	1.3	5.4	0.2	0.8	0	0	0.6	2.5	0.7	3.1	1.6	6.8
	OXA48	143	1.2	6.2	0.3	1.4	0	0	0.5	2.4	0.7	3.7	1.5	7.7
NDM/OXA (2)	NDM	143	1.2	5.3	0.2	1.1	0	0	0.5	2.4	0.8	3.5	1.6	6.9
	OXA48	143	1.2	6.0	0.2	1.2	0	0	0.5	2.5	0.7	3.8	1.5	7.6
NEG	SPC	144	0.1	0.3	0.1	0.3	0	0	0.2	0.5	0.4	1.3	0.5	1.5

a. Results with non-zero Ct values out of 144.

## Appendix

### Bibliography

1. Kallen AJ, et al. 2010. Current epidemiology of multidrug-resistant gram-negative bacilli in the United States. *Infect Control Hosp Epidemiol*. 31 Suppl 1: S51–54.
2. Nordmann P, et al. 2012. Carbapenemase-producing *Enterobacteriaceae*: a call for action! *Clin Microbiol Infect*. 18: 411–412.
3. Cornaglia G, et al. 2011. Metallo-beta-lactamases: a last frontier for beta-lactams? *Lancet Infect Dis*. 11: 381–393.
4. Kitchel B, et al. 2009. Molecular epidemiology of KPC-producing *Klebsiella pneumoniae* in the United States: Clonal expansion of MLST sequence type 258. *Antimicrob Agents Chemother*. 53:3365–3370.
5. Schwaber MJ, et al. 2011. Containment of a country-wide outbreak of carbapenem-resistant *Klebsiella pneumoniae* in Israeli hospitals via a nationally implemented intervention. *Clin Infect Dis*. 52: 848–855.
6. Kumarasamy KK, et al. 2010. Emergence of a new antibiotic resistance mechanism in India, Pakistan, and the UK: a molecular, biological, and epidemiological study. *Lancet Infect Dis*. 10: 597–602.
7. Cuzon G, et al. 2008. Plasmid-encoded carbapenem-hydrolyzing beta-lactamase OXA-48 in an imipenem-susceptible *Klebsiella pneumoniae* strain from Belgium. *Antimicrob Agents Chemother*. 52: 3463–3464.
8. Nordmann P, et al. 2011. Global spread of carbapenemase-producing *Enterobacteriaceae*. *Emerg Infect Dis*. 17: 1791–1798.
9. Grundmann H, et al. 2010. Carbapenem-non-susceptible *Enterobacteriaceae* in Europe: conclusions from a meeting of national experts. *Euro Surveill*. 15:1-13.
10. van Duin D, et al. 2016. Ceftazidime/avibactam and ceftolozane/tazobactam: second-generation  $\beta$ -lactam/ $\beta$ -lactamase inhibitor combinations. *Clin Infect Dis*. 63(2):234-241.
11. Falcone M, Paterson D. 2016. Spotlight on ceftazidime/avibactam: a new option for MDR gram-negative infections. *J Antimicrob*. 71(10):2713-2722.
12. Navas, M and Jacobs M. 2016. Carbapenem Resistant *Enterobacteriaceae* - A review for laboratorians. American Association for Clinical Chemistry (AACC) Clinical Laboratory News.
13. Vasoo S, et al. 2015. In vitro activities of ceftazidime-avibactam, aztreonam-avibactam, and a panel of older and contemporary antimicrobial agents against carbapenemase-producing gram-negative bacilli. *Antimicrob Agents Chemother*. 59(12):7842-7846.
14. Avycaz package insert. Section 14.2 Microbiology.
15. Centers for Disease Control and Prevention. Biosafety in Microbiological and Biomedical laboratories (refer to latest edition). <http://www.cdc.gov/biosafety/publications/>



16. Centers for Disease Control and Prevention. Accessed January 20, 2016. Healthcare-associated Infections (HAIs). <http://www.cdc.gov/hai/organisms/cre/cre-facilities.html>
17. Clinical and Laboratory Standards Institute. Protection of Laboratory Workers from Occupationally Acquired Infections; Approved Guideline. Document M29 (refer to latest edition).
18. REGULATION (EC) No 1272/2008 OF THE EUROPEAN PARLIAMENT AND OF THE COUNCIL of 16 December 2008 on the classification labeling and packaging of substances and mixtures amending and repealing, List of Precautionary Statements, Directives 67/548/EEC and 1999/45/EC (amending Regulation (EC) No 1907/2007).
19. Occupational Safety and Health Standards, Hazard Communication, Toxic and Hazard Substances (March 26, 2012) (29 C.F.R., pt. 1910, subpt. Z).
20. CLSI M100. Performance Standards for Antimicrobial Susceptibility Testing, CLSI, 940 West Valley Road, Suite 1400, Wayne, PA 19087-1898 USA (refer to latest edition).
21. CLSI M07-A10. 2015. Methods for Dilution Antimicrobial Susceptibility Test for Bacteria that Grow Aerobically; Tenth Edition, CLSI, 940 West Valley Road, Suite 1400, Wayne, PA 19087-1898 USA.
22. CLSI M100-S24. 2014. Performance Standards for Antimicrobial Susceptibility Testing; Twenty-Fourth Edition, CLSI, 940 West Valley Road, Suite 1400, Wayne, PA 19087-1898 USA.
23. CLSI M07-A9. 2012. Methods for Dilution Antimicrobial Susceptibility Test for Bacteria that Grow Aerobically; Ninth Edition, CLSI, 940 West Valley Road, Suite 1400, Wayne, PA 19087-1898 USA.

## Cepheid Headquarters Locations

### Corporate Headquarters

Cepheid  
904 Caribbean Drive  
Sunnyvale, CA 94089  
USA

Telephone: + 1 408 541 4191  
Fax: + 1 408 541 4192  
[www.cepheid.com](http://www.cepheid.com)

### European Headquarters

Cepheid Europe SAS  
Vira Solelh  
81470 Maurens-Scopont  
France

Telephone: + 33 563 825 300  
Fax: + 33 563 825 301  
[www.cepheidinternational.com](http://www.cepheidinternational.com)

## Technical Assistance

Before contacting Cepheid Technical Support, collect the following information:

- Product name
- Lot number
- Serial number of the instrument



- Error messages (if any)
- Software version and, if applicable, Computer Service Tag number

## US













Telephone: + 1 888 838 3222  
Email: techsupport@cepheid.com

## France

Telephone: + 33 563 825 319  
Email: support@cepheideurope.com

Contact information for all Cepheid Technical Support offices is available on our website: [www.cepheid.com/en\\_US/support/contact-us](http://www.cepheid.com/en_US/support/contact-us).

## Table of Symbols

Symbol	Meaning
	Catalog number
	<i>In vitro</i> diagnostic medical device
	Do not reuse
	Batch code
	Consult instructions for use
	Caution
	Manufacturer
	Country of manufacture
	Contains sufficient for $n$ tests
	Control
	Expiration date
	Temperature limitation
	Biological risks



Symbol	Meaning
	Warning
	For prescription use only



Cepheid  
904 Caribbean Drive  
Sunnyvale, CA 94089  
USA

Telephone: + 1 408 541 4191  
Fax: + 1 408 541 4192



## Revision History

**Description of Changes:** 303-0945 Rev. A

**Purpose:** Initial release

